



# AHŞAP DÜNYASI

KENT MOBİLYALARI

# HAKKIMIZDA

Firmamız Ahşap Dünyası 2000 yılında aktif olarak sizlere hizmet vermeye başlamıştır. Kuruluş tarihimiz itibari ile Türkiye'nin hemen her ilinde sayısız çalışma ve uygulamalara imza atmış ve tüm çalışmalarıyla büyük beğeni toplamış olmanın gururunu yaşamaktayız.

Firma olarak, kaliteden ödün vermeden, aldığımız işleri zamanında ve eksiksiz tamamlamayı birincil prensibimiz olarak belirlemiş bulunmaktayız. Bu prensip sayesinde firmamız kısa süreçte hem pazarda hem de sektörde önemli bir yer ve ün kazanmıştır. Bundan dolayı şirketimiz çalışanları ve yönetimimiz için süreklilik ve alanında en iyi olma, vazgeçilmez misyonumuz olarak kabul edilmiştir.

Üretim tesislerimiz ile sunduğumuz hizmetlerimiz;

- Kamelya, bank, çöp kovası gibi kent mobilyaları,
- Ahşap ve metal çocuk oyun parkları ve oyun ekipmanları,
- Çit, iskele ve ahşap köprüler,
- Spor sahaları ve emin döşemeleri.

Tasarım ve projelerimiz;

- Park ve bahçe düzenlemeleri,
- Peyzaj projeleri tasarım ve uygulamaları,
- Ahşap konstrüksiyon mimari proje tasarım ve uygulamaları.

Siz sevgili dostlarımıza en iyisini sunmak için durmadan çalışmamızın en büyük karşılığı, yüzünüzdeki tebessüm e memnuniyetinizdir.

Saygılarımızla...



**AHŞAP DÜNYASI**  
KENT MOBİLYALARI





# İÇİNDEKİLER

1	AHŞAP OYUN EVİ	97	EKİPMANLAR
3	AHŞAP OYUN GRUPLARI	109	KÜLTÜR-FİZİK
17	KALE OYUN GRUPLARI	115	DIŞ MEKAN SPOR ALET.
23	ORMAN OYUN GRUPLARI	125	KAMELYALAR
29	TREN OYUN GRUPLARI	131	PERGOLELER
35	GEMİ OYUN GRUPLARI	137	PİKNİK MASALARI
41	EKO OYUN GRUPLARI	141	BANKLAR
57	ENGELSİZ OYUN GRUPLARI	149	ÇÖP KOVALARI
63	AKASYA OYUN GRUPLARI	155	GERİ DÖNÜŞÜM ÜNİT.
69	TOKİ OYUN GRUPLARI	159	ÇİÇEKLİKLER
75	AHŞAP OYUN PARKURU	161	BİSİKLET PARKLARI
79	AHŞAP OYUN PARKURU EKİP.	163	AHŞAP ÇİTLER
89	METAL OYUN PARKURU	165	HAYVAN BARINAKLARI
93	METAL OYUN PARKURU EKİP.	167	DİĞER EKİPMANLAR





# AHŞAP DÜNYASI

KENT MOBİLYALARI



*Ahşap  
Oyun Evi*



## TEKNİK ÖZELLİKLER

- 1. SINIF SARIÇAM
- VAKUMLU BASINÇLI EMPRENYE KORUMALI
- SUBAZLI AHŞAP BOYASI
- POLİETİLEN PLASTİK EKİPMANLAR



2

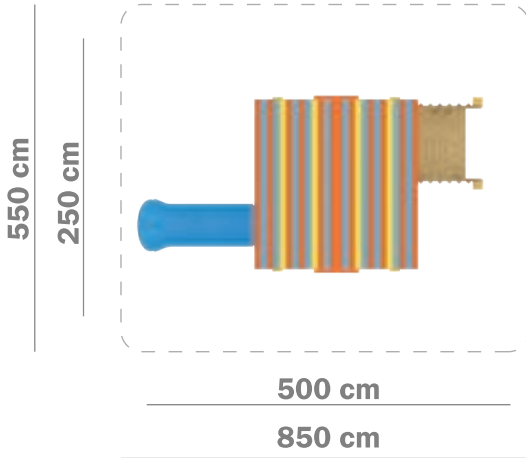

5  
Kişi

Kapasite

3  
yaş +

Yaş Grubu

Ürün Kodu  
AOE - 01

- H:100 cm DALGALI KAYDIRAK 1 ADET
- AHŞAP MERDİVEN 1 ADET
- AHŞAP OYUN EVİ 1 ADET





# AHSAP DÜNYASI

KENT MOBİLYALARI



*Ahsap Oyun  
Grupları*



## TEKNİK ÖZELLİKLER

- 1. SINIF SARIÇAM
- VAKUMLU BASINÇLI EMPRENYE KORUMALI
- SUBAZLI AHŞAP BOYASI
- POLİETİLEN PLASTİK EKİPMANLAR

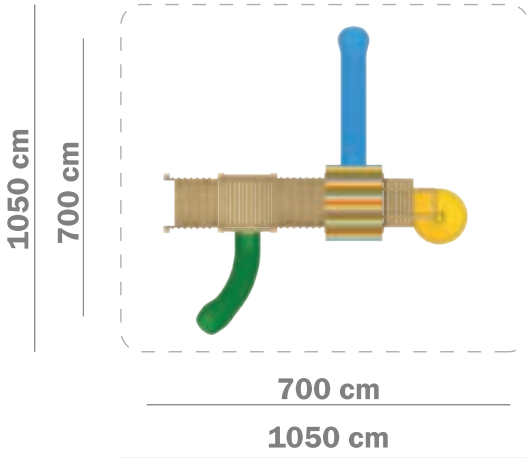

19  
Kişi

Kapasite

5  
yaş +

Yaş Grubu

Ürün Kodu  
AOG - 01

- H:200 cm HELEZON KAYDIRAK 1 ADET
- H:200 cm DÜZ KAYDIRAK 1 ADET
- H:100 cm EĞRİ KAYDIRAK 1 ADET
- AHŞAP KARE PLATFORM 1 ADET
- AHŞAP HELEZON PLATFORM 1 ADET
- AHŞAP MERDİVEN 2 ADET
- AHŞAP BEŞİK ÇATI 1 ADET
- AHŞAP KORKULUK 2 ADET



# AHŞAP OYUN GRUPLARI



## TEKNİK ÖZELLİKLER

- 1. SINIF SARIÇAM
- VAKUMLU BASINÇLI EMPRENYE KORUMALI
- SUBAZLI AHŞAP BOYASI
- POLİETİLEN PLASTİK EKİPMANLAR

5



Ürün Kodu  
**AOG - 02**

22  
Kişi

Kapasite

5  
yaş +

Yaş Grubu

- H:200 cm HELEZON KAYDIRAK 1 ADET
- H:200 cm DÜZ KAYDIRAK 1 ADET
- H:100 cm TÜP KAYDIRAK 1 ADET
- H:100 cm DALGALI KAYDIRAK 1 ADET
- AHŞAP KARE PLATFORM 2 ADET
- AHŞAP HELEZON PLATFORM 1 ADET
- AHŞAP MERDİVEN 2 ADET
- AHŞAP BEŞİK ÇATI 2 ADET
- AHŞAP KORKULUK 2 ADET
- AHŞAP KÖPRÜ 1 ADET
- H:100 cm KAKTÜS TIRMANMA 1 ADET

1050 cm

700 cm

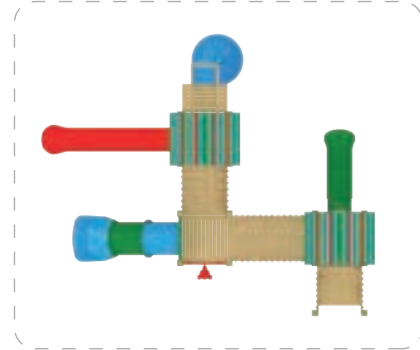

800 cm

1150 cm



**AHŞAP DÜNYASI**  
KENT MOBİLYALARI

[www.ahsapdunyasi.com.tr](http://www.ahsapdunyasi.com.tr)

[info@ahsapdunyasi.com.tr](mailto:info@ahsapdunyasi.com.tr)



## TEKNİK ÖZELLİKLER

- 1. SINIF SARIÇAM
- VAKUMLU BASINÇLI EMPRENYE KORUMALI
- SUBAZLI AHŞAP BOYASI
- POLİETİLEN PLASTİK EKİPMANLAR



6

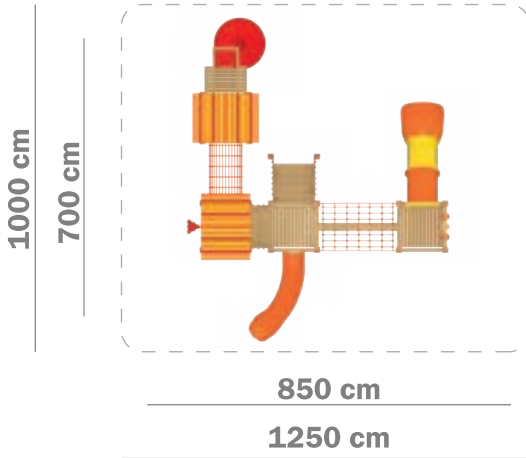

23  
Kişi

Kapasite

5  
yaş +

Yaş Grubu

Ürün Kodu  
AOG - 03

- H:150 cm HELEZON KAYDIRAK 1 ADET
- H:100 cm TÜP KAYDIRAK 1 ADET
- H:100 cm EĞRİ KAYDIRAK 1 ADET
- AHŞAP KARE PLATFORM 3 ADET
- AHŞAP HELEZON PLATFORM 1 ADET
- HALAT İP TÜNEL GEÇİŞ
- HALAT İP GEÇİŞ
- AHŞAP MERDİVEN 2 ADET
- AHŞAP BEŞİK ÇATI 2 ADET
- AHŞAP KORKULUK 4 ADET
- TİK TAK PANO 1 ADET
- H:150 cm KAKTÜS TIRMANMA 1 ADET





# AHŞAP OYUN GRUPLARI



## TEKNİK ÖZELLİKLER

- 1. SINIF SARIÇAM
- VAKUMLU BASINÇLI EMPRENYE KORUMALI
- SUBAZLI AHŞAP BOYASI
- POLİETİLEN PLASTİK EKİPMANLAR

7



Ürün Kodu  
**AOG - 04**

24  
Kişi

Kapasite

5  
yaş +

Yaş Grubu

- H:200 cm HELEZON KAYDIRAK 1 ADET
- H:100 cm EĞRİ KAYDIRAK 1 ADET
- H:100 cm DALGALI KAYDIRAK 1 ADET
- H:100 cm İKİLİ KAYDIRAK 1 ADET
- AHŞAP KARE PLATFORM 2 ADET
- AHŞAP HELEZON PLATFORM 1 ADET
- HALAT İP TÜNEL GEÇİŞ
- AHŞAP MERDİVEN 2 ADET
- TREN ÇATI 3 ADET
- TREN PANO 4 ADET
- AHŞAP KORKULUK 2 ADET
- TÜNEL GEÇİŞ 1 ADET
- METAL TREN ÖNÜ 1 ADET

900 cm

550 cm

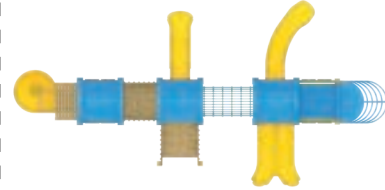

1100 cm

1450 cm



**AHŞAP DÜNYASI**  
KENT MOBİLYALARI

www.ahsapdunyasi.com.tr

info@ahsapdunyasi.com.tr



## TEKNİK ÖZELLİKLER

- 1. SINIF SARIÇAM
- VAKUMLU BASINÇLI EMPRENYE KORUMALI
- SUBAZLI AHŞAP BOYASI
- POLİETİLEN PLASTİK EKİPMANLAR
- SICAK DALDIRMA GALVANİZ ZİNCİR



8

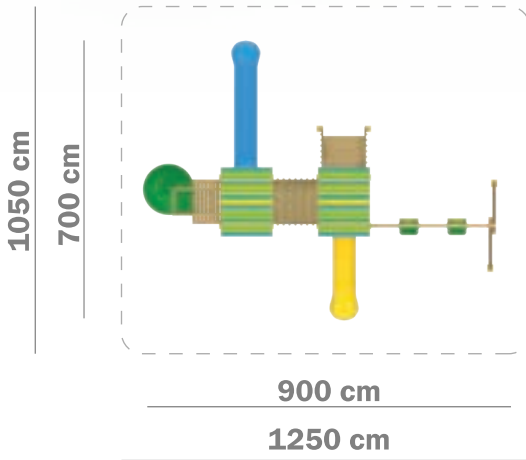

25  
Kişi

Kapasite

5  
yaş +

Yaş Grubu

Ürün Kodu  
AOG - 05

- H:200 cm HELEZON KAYDIRAK 1 ADET
- H:200 cm DÜZ KAYDIRAK 1 ADET
- H:100 cm DÜZ KAYDIRAK 1 ADET
- AHŞAP KARE PLATFORM 1 ADET
- AHŞAP HELEZON PLATFORM 1 ADET
- AHŞAP MERDİVEN 2 ADET
- AHŞAP BEŞİK ÇATI 2 ADET
- AHŞAP KORKULUK 2 ADET
- İKİLİ SALINCAK 1 ADET



# AHŞAP OYUN GRUPLARI



## TEKNİK ÖZELLİKLER

- 1. SINIF SARIÇAM
- VAKUMLU BASINÇLI EMPRENYE KORUMALI
- SUBAZLI AHŞAP BOYASI
- POLİETİLEN PLASTİK EKİPMANLAR

9



Ürün Kodu  
**AOG - 06**

26  
Kişi

Kapasite

5  
yaş +

Yaş Grubu

- H:150 cm HELEZON KAYDIRAK 1 ADET
- H:150 cm DÜZ KAYDIRAK 1 ADET
- H:100 cm EĞRİ KAYDIRAK 1 ADET
- H:100 cm İKİLİ KAYDIRAK 1 ADET
- AHŞAP KARE PLATFORM 1 ADET
- AHŞAP HELEZON PLATFORM 1 ADET
- AHŞAP ALTİGEN PLATFORM 1 ADET
- H:50 cm AHŞAP RAMPA 1 ADET
- AHŞAP MERDİVEN 1 ADET
- AHŞAP BEŞİK ÇATI 2 ADET
- AHŞAP KORKULUK 4 ADET
- H:100 cm KAKTÜS TIRMANMA 1 ADET
- TEMATİK FİGÜR 2 ADET

1050 cm

700 cm

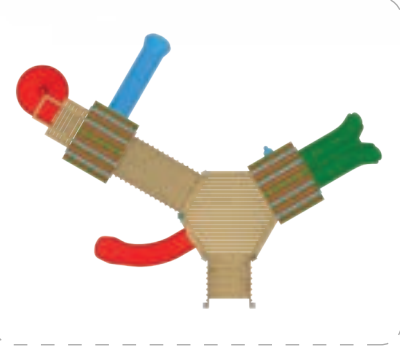

950 cm

1300 cm



**AHŞAP DÜNYASI**  
KENT MOBİLYALARI

[www.ahsapdunyasi.com.tr](http://www.ahsapdunyasi.com.tr)

[info@ahsapdunyasi.com.tr](mailto:info@ahsapdunyasi.com.tr)





## TEKNİK ÖZELLİKLER

- 1. SINIF SARIÇAM
- VAKUMLU BASINÇLI EMPRENYE KORUMALI
- SUBAZLI AHŞAP BOYASI
- POLİETİLEN PLASTİK EKİPMANLAR



10

1000 cm

650 cm

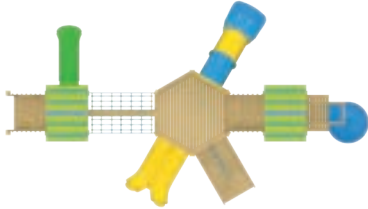

1100 cm

1400 cm

28

Kişi

Kapasite

5

yaş +

Yaş Grubu

Ürün Kodu  
AOG - 07

- H:200 cm HELEZON KAYDIRAK 1 ADET
- H:100 cm TÜP KAYDIRAK 1 ADET
- H:100 cm DALGALI KAYDIRAK 1 ADET
- H:100 cm İKİLİ KAYDIRAK 1 ADET
- AHŞAP KARE PLATFORM 1 ADET
- AHŞAP HELEZON PLATFORM 1 ADET
- AHŞAP ALTIGEN PLATFORM 1 ADET
- HALAT İP GEÇİŞ
- AHŞAP MERDİVEN 2 ADET
- AHŞAP BEŞİK ÇATI 2 ADET
- AHŞAP KORKULUK 4 ADET
- H:100 cm AHŞAP RAMPA 1 ADET



# AHŞAP OYUN GRUPLARI



## TEKNİK ÖZELLİKLER

- 1. SINIF SARIÇAM
- VAKUMLU BASINÇLI EMPRENYE KORUMALI
- SUBAZLI AHŞAP BOYASI
- POLİETİLEN PLASTİK EKİPMANLAR

11



Ürün Kodu  
**AOG - 08**

34  
Kişi

Kapasite

5  
yaş +

Yaş Grubu

- H:200 cm HELEZON KAYDIRAK 1 ADET
- H:200 cm TÜP KAYDIRAK 1 ADET
- H:200 cm DÜZ KAYDIRAK 1 ADET
- H:100 cm DALGALI KAYDIRAK 1 ADET
- H:100 cm İKİLİ KAYDIRAK 1 ADET
- AHŞAP KARE PLATFORM 3 ADET
- AHŞAP HELEZON PLATFORM 1 ADET
- HALAT İP GEÇİŞ
- AHŞAP MERDİVEN 3 ADET
- AHŞAP BEŞİK ÇATI 2 ADET
- AHŞAP KORKULUK 3 ADET
- H:100cm KAKTÜS TIRMANMA 1 ADET

1100 cm

750 cm

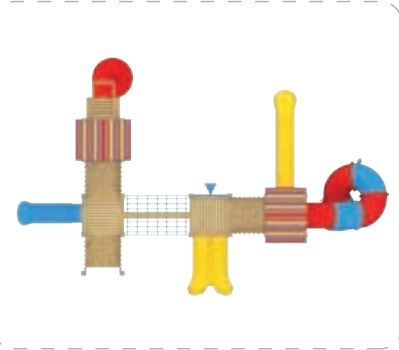

1150 cm

1500 cm



**AHŞAP DÜNYASI**  
KENT MOBİLYALARI

www.ahsapdunyasi.com.tr

info@ahsapdunyasi.com.tr



## TEKNİK ÖZELLİKLER

- 1. SINIF SARIÇAM
- VAKUMLU BASINÇLI EMPRENYE KORUMALI
- SUBAZLI AHŞAP BOYASI
- POLİETİLEN PLASTİK EKİPMANLAR



12

1100 cm

750 cm

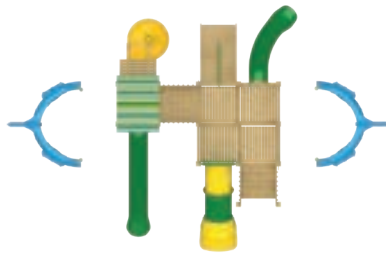

1150 cm

1450 cm

34

Kişi

Kapasite

5

yaş +

Yaş Grubu

Ürün Kodu  
AOG - 09

- H:200 cm HELEZON KAYDIRAK 1 ADET
- H:200 cm DÜZ KAYDIRAK 1 ADET
- H:100 cm TÜP KAYDIRAK 1 ADET
- H:100 cm EĞRİ KAYDIRAK 1 ADET
- AHŞAP KARE PLATFORM 4 ADET
- AHŞAP HELEZON PLATFORM 1 ADET
- AHŞAP MERDİVEN 2 ADET
- AHŞAP BEŞİK ÇATI 1 ADET
- AHŞAP KORKULUK 4 ADET
- H:100 cm AHŞAP RAMPA 1 ADET
- FİĞÜR 2 ADET
- GEMİ ÖNÜ 2 ADET





# AHŞAP OYUN GRUPLARI



## TEKNİK ÖZELLİKLER

- 1. SINIF SARIÇAM
- VAKUMLU BASINÇLI EMPRENYE KORUMALI
- SUBAZLI AHŞAP BOYASI
- POLİETİLEN PLASTİK EKİPMANLAR

13



Ürün Kodu  
**AOG - 10**

40  
Kişi

Kapasite

5  
yaş +

Yaş Grubu

- H:200 cm HELEZON KAYDIRAK 1 ADET
- H:200 cm DÜZ KAYDIRAK 1 ADET
- H:100 cm TÜP KAYDIRAK 1 ADET
- H:100 cm EĞRİ KAYDIRAK 1 ADET
- H:100 cm İKİLİ KAYDIRAK 1 ADET
- AHŞAP KARE PLATFORM 3 ADET
- AHŞAP HELEZON PLATFORM 1 ADET
- H:100 cm AHŞAP RAMPA 1 ADET
- AHŞAP MERDİVEN 2 ADET
- AHŞAP KARE ÇATI 3 ADET
- AHŞAP KORKULUK 3 ADET
- AHŞAP YATAY MERDİVEN 1 ADET
- AHŞAP KÖPRÜ 1 ADET

1350 cm

1000 cm



1000 cm

1350 cm



**AHŞAP DÜNYASI**  
KENT MOBİLYALARI

[www.ahsapdunyasi.com.tr](http://www.ahsapdunyasi.com.tr)

[info@ahsapdunyasi.com.tr](mailto:info@ahsapdunyasi.com.tr)





## TEKNİK ÖZELLİKLER

- 1. SINIF SARIÇAM
- VAKUMLU BASINÇLI EMPRENYE KORUMALI
- SUBAZLI AHŞAP BOYASI
- POLİETİLEN PLASTİK EKİPMANLAR



14

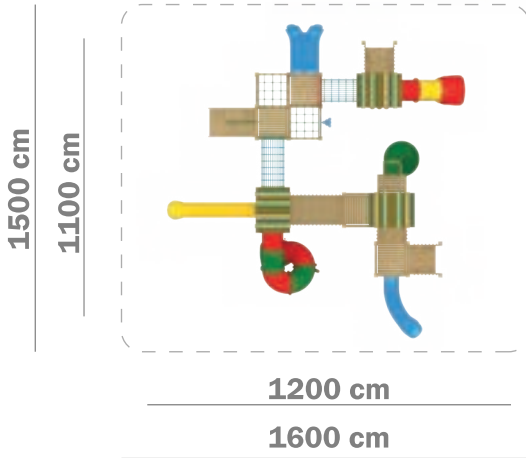

52  
Kişi

Kapasite

5  
yaş +

Yaş Grubu

Ürün Kodu  
AOG - 11

- H:200 cm TÜP KAYDIRAK 1 ADET
- H:200 cm DÜZ KAYDIRAK 1 ADET
- H:150 cm HELEZON KAYDIRAK 1 ADET
- H:100 cm TÜP KAYDIRAK 1 ADET
- H:100 cm EĞRİ KAYDIRAK 1 ADET
- H:100 cm İKİLİ KAYDIRAK 1 ADET
- AHŞAP KARE PLATFORM 6 ADET
- AHŞAP HELEZON PLATFORM 1 ADET
- HALAT İP PLATFORM 2 ADET
- HALAT İP TÜNEL GEÇİŞ

- HALAT İP TÜNEL RAMPA
- AHŞAP MERDİVEN 3 ADET
- AHŞAP BEŞİK ÇATI 3 ADET
- AHŞAP KORKULUK 6 ADET
- TİK TAK PANO 2 ADET
- H:100 cm AHŞAP RAMPA 1 ADET
- H:50 cm AHŞAP RAMPA 1 ADET
- FİĞÜR 4 ADET
- KAKTÜS TIRMANMA 1 ADET



# AHŞAP OYUN GRUPLARI



## TEKNİK ÖZELLİKLER

- 1. SINIF SARIÇAM
- VAKUMLU BASINÇLI EMPRENYE KORUMALI
- SUBAZLI AHŞAP BOYASI
- POLİETİLEN PLASTİK EKİPMANLAR
- SICAK DALDIRMA GALVANİZ ZİNCİR

15



Ürün Kodu  
AOG - 12

62  
Kişi

Kapasite

5  
yaş +

Yaş Grubu

- H:200 cm HELEZON KAYDIRAK 1 ADET
- H:200 cm TÜP KAYDIRAK 1 ADET
- H:200 cm DÜZ KAYDIRAK 1 ADET
- H:100 cm TÜP KAYDIRAK 1 ADET
- H:100 cm DÜZ KAYDIRAK 1 ADET
- H:100 cm EĞRİ KAYDIRAK 1 ADET
- H:100 cm İKİLİ KAYDIRAK 1 ADET
- AHŞAP KARE PLATFORM 2 ADET
- AHŞAP HELEZON PLATFORM 1 ADET
- AHŞAP ALTİGEN PLATFORM 2 ADET
- AHŞAP KÖPRÜ 2 ADET
- AHŞAP MERDİVEN 3 ADET
- AHŞAP KARE ÇATI 2 ADET
- AHŞAP ALTİGEN ÇATI 1 ADET
- AHŞAP KORKULUK 6 ADET
- H:100 cm AHŞAP RAMPA 1 ADET
- FİGÜR 2 ADET
- İKİLİ SALINCAK 1 ADET

1600 cm

1200 cm

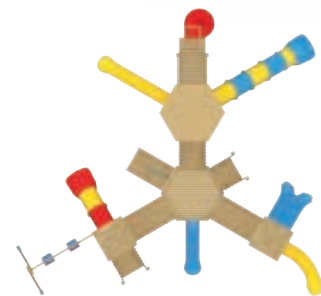

1300 cm

1650 cm



**AHŞAP DÜNYASI**  
KENT MOBİLYALARI

www.ahsapdunyasi.com.tr

info@ahsapdunyasi.com.tr



## TEKNİK ÖZELLİKLER

- 1. SINIF SARIÇAM
- VAKUMLU BASINÇLI EMPRENYE KORUMALI
- SUBAZLI AHŞAP BOYASI
- POLİETİLEN PLASTİK EKİPMANLAR



16

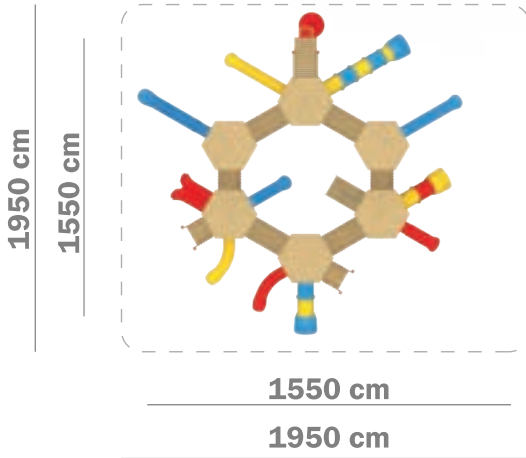

96

Kişi

Kapasite

5

yaş +

Yaş Grubu

Ürün Kodu  
AOG - 13

- H:200 cm HELEZON KAYDIRAK 1 ADET
- H:200 cm TÜP KAYDIRAK 1 ADET
- H:200 cm DÜZ KAYDIRAK 2 ADET
- H:200 cm DALGALI KAYDIRAK 1 ADET
- H:100 cm TÜP KAYDIRAK 2 ADET
- H:100 cm DÜZ KAYDIRAK 1 ADET
- H:100 cm DALGALI KAYDIRAK 1 ADET
- H:100 cm İKİLİ KAYDIRAK 1 ADET
- H:100 cm EĞRİ KAYDIRAK 2 ADET
- AHŞAP HELEZON PLATFORM 1 ADET
- AHŞAP ALTİGEN PLATFORM 6 ADET
- AHŞAP KÖPRÜ 4 ADET
- AHŞAP MERDİVEN 4 ADET
- AHŞAP ALTİGEN ÇATI 6 ADET
- AHŞAP KORKULUK 6 ADET
- H:100 cm AHŞAP RAMPA 1 ADET
- TİK TAK PANO 2 ADET







# AHŞAP DÜNYASI

KENT MOBİLYALARI



*Kale Oyun  
Grupları*

## TEKNİK ÖZELLİKLER

- SICAK DALDIRMA GALVANİZ TAŞIYICI
- METAL AKSAMLAR ELEKTROSTATİK TOZ BOYALI
- POLİETİLEN PLASTİK EKİPMANLAR



18

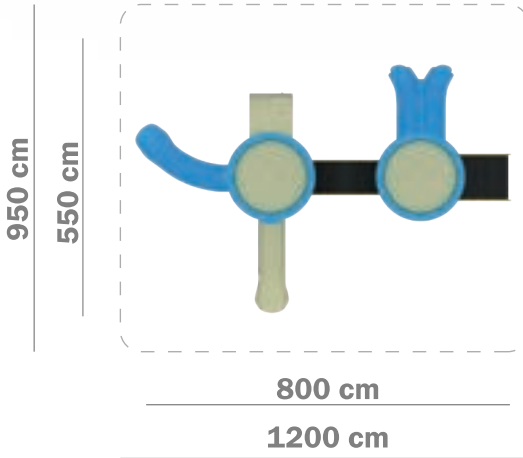

17

Kişi

Kapasite

5

yaş +

Yaş Grubu

Ürün Kodu  
KOG - 01

- H:100 cm İKİLİ KAYDIRAK 1 ADET
- H:100 cm EĞRİ KAYDIRAK 1 ADET
- H:100 cm DÜZ KAYDIRAK 1 ADET
- KARE PLATFORM 2 ADET
- MERDİVEN 1 ADET
- KONİK ÇATI 2 ADET

- PANO 1 ADET
- ÜST PANO 5 ADET
- KAYA TIRMANMA 1 ADET
- KÖPRÜ 1 ADET







## TEKNİK ÖZELLİKLER

- SICAK DALDIRMA GALVANİZ TAŞIYICI
- METAL AKSAMLAR ELEKTROSTATİK TOZ BOYALI
- POLİETİLEN PLASTİK EKİPMANLAR

19



Ürün Kodu  
**KOG - 02**

**35**  
Kişi

Kapasite

**5**

yaş +

Yaş Grubu

- H:200 cm HELEZON KAYDIRAK 1 ADET
- H:100 cm DALGALI KAYDIRAK 1 ADET
- H:100 cm TÜP KAYDIRAK 1 ADET
- H:100 cm İKİLİ KAYDIRAK 1 ADET
- H:100 cm EĞRİ KAYDIRAK 1 ADET
- H:100 cm DÜZ KAYDIRAK 1 ADET
- KARE PLATFORM 4 ADET
- HELEZON PLATFORM 1 ADET
- MERDİVEN 3 ADET
- KONİK ÇATI 1 ADET
- PANO 3 ADET
- ÜST PANO 10 ADET
- KAKTÜS TIRMANMA 1 ADET
- TİKTAK PANO 1 ADET
- KÖPRÜ 2 ADET

1250 cm

850 cm

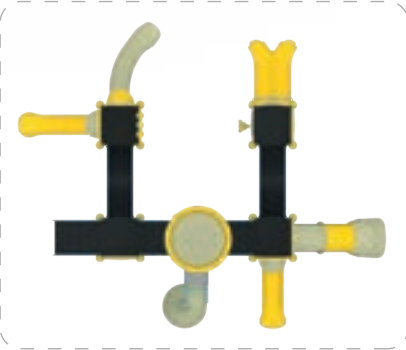

1050 cm

1450 cm



**AHŞAP DÜNYASI**  
KENT MOBİLYALARI



## TEKNİK ÖZELLİKLER

- SICAK DALDIRMA GALVANİZ TAŞIYICI
- METAL AKSAMLAR ELEKTROSTATİK TOZ BOYALI
- POLİETİLEN PLASTİK EKİPMANLAR



20

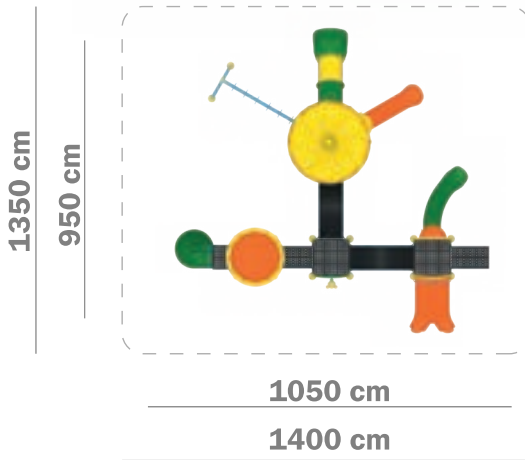

38  
Kişi

Kapasite

5  
yaş +

Yaş Grubu

Ürün Kodu  
KOG - 03

- H:200 cm HELEZON KAYDIRAK 1 ADET
- H:100 cm İKİLİ KAYDIRAK 1 ADET
- H:100 cm EĞRİ KAYDIRAK 1 ADET
- H:100 cm DÜZ KAYDIRAK 1 ADET
- H:100 cm TÜP KAYDIRAK 1 ADET
- KARE PLATFORM 2 ADET
- HELEZON PLATFORM 1 ADET
- ALTİGEN PLATFORM 1 ADET
- MERDİVEN 2 ADET
- KONİK ÇATI 1 ADET
- ALTİGEN ÇATI 1 ADET
- PANO 4 ADET
- ÜST PANO 10 ADET
- KAKTÜS TIRMANMA 1 ADET
- KÖPRÜ 2 ADET
- KOMANDO MERDİVEN 1 ADET







## TEKNİK ÖZELLİKLER

- SICAK DALDIRMA GALVANİZ TAŞIYICI
- METAL AKSAMLAR ELEKTROSTATİK TOZ BOYALI
- POLİETİLEN PLASTİK EKİPMANLAR

21



Ürün Kodu  
**KOG - 04**

**41**  
Kişi

Kapasite

**5**  
yaş +

Yaş Grubu

- H:200 cm HELEZON KAYDIRAK 1 ADET
- H:200 cm DÜZ KAYDIRAK 1 ADET
- H:150 cm DÜZ KAYDIRAK 1 ADET
- H:100 cm EĞRİ KAYDIRAK 1 ADET
- H:100 cm TÜP KAYDIRAK 1 ADET
- H:100 cm İKİLİ KAYDIRAK 1 ADET
- KARE PLATFORM 5 ADET
- HELEZON PLATFORM 1 ADET
- MERDİVEN 2 ADET
- KONİK ÇATI 2 ADET
- PANO 6 ADET
- ÜST PANO 12 ADET
- KAKTÜS TIRMANMA 1 ADET
- KÖPRÜ 1 ADET

1200 cm

800 cm

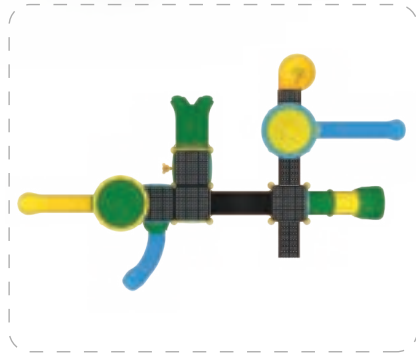

1300 cm

1700 cm



**AHŞAP DÜNYASI**  
KENT MOBİLYALARI



## TEKNİK ÖZELLİKLER

- SICAK DALDIRMA GALVANİZ TAŞIYICI
- METAL AKSAMLAR ELEKTROSTATİK TOZ BOYALI
- POLİETİLEN PLASTİK EKİPMANLAR



22

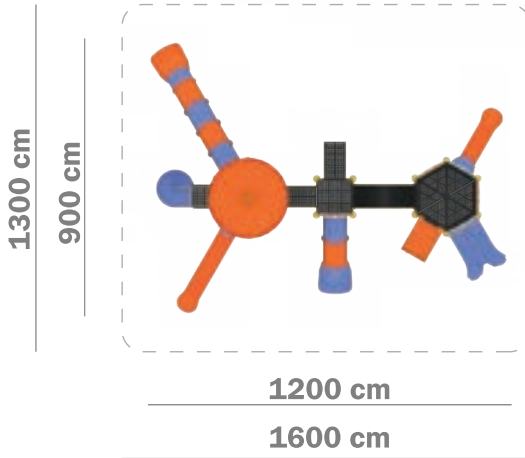

43  
Kişi

Kapasite

5  
yaş +

Yaş Grubu

İrün Kodu  
KOG - 05

- H:200 cm HELEZON KAYDIRAK 1 ADET
- H:200 cm DÜZ KAYDIRAK 1 ADET
- H:200 cm TÜP KAYDIRAK 1 ADET
- H:100 cm DÜZ KAYDIRAK 1 ADET
- H:100 cm TÜP KAYDIRAK 1 ADET
- H:100 cm İKİLİ KAYDIRAK 1 ADET
- KARE PLATFORM 1 ADET
- ALTİGEN PLATFORM 2 ADET
- HELEZON PLATFORM 1 ADET
- MERDİVEN 2 ADET
- ALTİGEN ÇATI 1 ADET
- PANO 4 ADET
- ÜST PANO 9 ADET
- KAYA TIRMANMA 1 ADET
- KÖPRÜ 1 ADET







# AHSAP DÜNYASI

KENT MOBİLYALARI



*Orman Oyun  
Grupları*

## TEKNİK ÖZELLİKLER

- SICAK DALDIRMA GALVANİZ TAŞIYICI
- METAL AKSAMLAR ELEKTROSTATİK TOZ BOYALI
- POLİETİLEN PLASTİK EKİPMANLAR



24

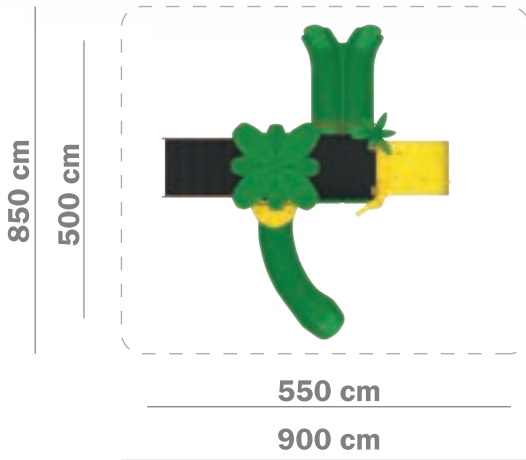

11  
Kişi

Kapasite

5  
yaş +

Yaş Grubu

Ürün Kodu  
00G - 01

- H:100 cm İKİLİ KAYDIRAK 1 ADET
- H:100 cm EĞRİ KAYDIRAK 1 ADET
- KARE PLATFORM 2 ADET
- MERDİVEN 1 ADET
- YAPRAK ÇATI 1 ADET

- PANO 2 ADET
- KAYA TIRMANMA 1 ADET
- TEMATİK FİGÜR 2 ADET





# ORMAN OYUN GRUPLARI



## TEKNİK ÖZELLİKLER

- SICAK DALDIRMA GALVANİZ TAŞIYICI
- METAL AKSAMLAR ELEKTROSTATİK TOZ BOYAL
- METAL AKSAMLAR ELEKTROSTATİK TOZ BOYALI

25



Ürün Kodu  
**00G - 02**

24  
Kişi

Kapasite

5  
yaş +

Yaş Grubu

- H:200 cm HELEZON KAYDIRAK 1 ADET
- H:200 cm DÜZ KAYDIRAK 1 ADET
- H:100 cm DALGALI KAYDIRAK 1 ADET
- H:100 cm DÜZ KAYDIRAK 1 ADET
- KARE PLATFORM 3 ADET
- HELEZON PLATFORM 1 ADET
- MERDİVEN 2 ADET
- YAPRAK ÇATI 1 ADET
- KOZALAK ÇATI 1 ADET
- PANO 3 ADET
- TİKTAK PANO 1 ADET
- TÜNEL GEÇİŞ 1 ADET
- KAYA TIRMANMA 1 ADET
- TEMATİK FİĞÜR 2 ADET

1000 cm

600 cm

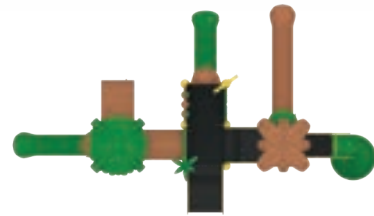

1000 cm

1400 cm



**AHSAP DÜNYASI**  
KENT MOBİLYALARI

www.ahsapdunyasi.com.tr

info@ahsapdunyasi.com.tr



## TEKNİK ÖZELLİKLER

- SICAK DALDIRMA GALVANİZ TAŞIYICI
- METAL AKSAMLAR ELEKTROSTATİK TOZ BOYALI
- POLİETİLEN PLASTİK EKİPMANLAR



26

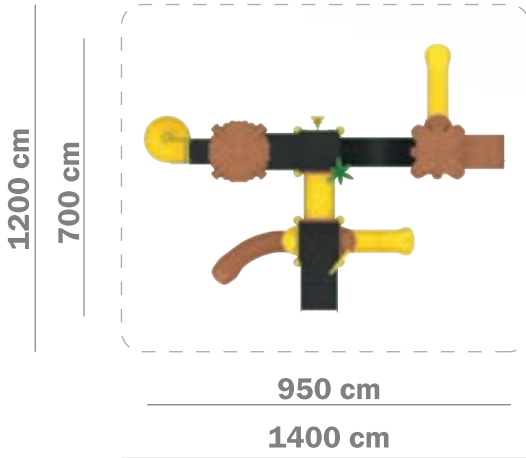

26  
Kişi

Kapasite

5  
yaş +

Yaş Grubu

Ürün Kodu  
00G - 03

- H:200 cm HELEZON KAYDIRAK 1 ADET
- H:100 cm DÜZ KAYDIRAK 1 ADET
- H:100 cm DALGALI KAYDIRAK 1 ADET
- H:100 cm EĞRİ KAYDIRAK 1 ADET
- KARE PLATFORM 3 ADET
- HELEZON PLATFORM 1 ADET
- MERDİVEN 2 ADET
- YAPRAK ÇATI 1 ADET
- KOZALAK ÇATI 1 ADET
- PANO 3 ADET
- TÜNEL GEÇİŞ 1 ADET
- KAKTÜS TIRMANMA 1 ADET
- KAYA TIRMANMA 1 ADET
- TEMATİK FİĞÜR 2 ADET
- KÖPRÜ 1 ADET





## TEKNİK ÖZELLİKLER

- SICAK DALDIRMA GALVANİZ TAŞIYICI
- METAL AKSAMLAR ELEKTROSTATİK TOZ BOYALI
- POLİETİLEN PLASTİK EKİPMANLAR

27



Ürün Kodu  
**00G - 04**

27  
Kişi

Kapasite

5  
yaş +

Yaş Grubu

- H:200 cm HELEZON KAYDIRAK 1 ADET
- H:200 cm DÜZ KAYDIRAK 1 ADET
- H:100 cm TÜP KAYDIRAK 1 ADET
- H:100 cm DALGALI KAYDIRAK 1 ADET
- H:100 cm DÜZ KAYDIRAK 1 ADET
- KARE PLATFORM 1 ADET
- HELEZON PLATFORM 1 ADET
- ALTİGEN PLATFORM 1 ADET
- MERDİVEN 2 ADET
- YAPRAK ÇATI 1 ADET
- PANO 3 ADET
- TİKTAK PANO 1 ADET

1150 cm

750 cm

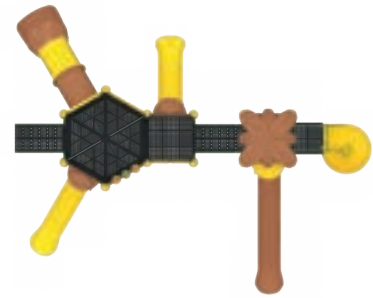

900 cm

1300 cm



**AHŞAP DÜNYASI**  
KENT MOBİLYALARI

www.ahsapdunyasi.com.tr

info@ahsapdunyasi.com.tr





## TEKNİK ÖZELLİKLER

- SICAK DALDIRMA GALVANİZ TAŞIYICI
- METAL AKSAMLAR ELEKTROSTATİK TOZ BOYALI
- POLİETİLEN PLASTİK EKİPMANLAR



28

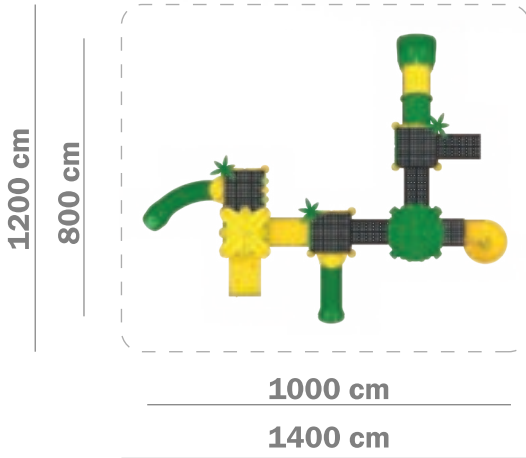

32  
Kişi

Kapasite

5  
yaş +

Yaş Grubu

Ürün Kodu  
00G - 05

- H:200 cm HELEZON KAYDIRAK 1 ADET
- H:100 cm TÜP KAYDIRAK 1 ADET
- H:100 cm DALGALI KAYDIRAK 1 ADET
- H:100 cm EĞRİ KAYDIRAK 1 ADET
- KARE PLATFORM 4 ADET
- HELEZON PLATFORM 1 ADET
- MERDİVEN 3 ADET
- YAPRAK ÇATI 1 ADET
- KOZALAK ÇATI 1 ADET
- PANO 5 ADET
- TİKTAK PANO 1 ADET
- TÜNEL GEÇİŞ 1 ADET
- KAYA TIRMANMA 1 ADET
- TEMATİK FİĞÜR 3 ADET





# AHŞAP DÜNYASI

KENT MOBİLYALARI



*Tren Oyun  
Grupları*



## TEKNİK ÖZELLİKLER

- SICAK DALDIRMA GALVANİZ TAŞIYICI
- METAL AKSAMLAR ELEKTROSTATİK TOZ BOYALI
- POLİETİLEN PLASTİK EKİPMANLAR



30

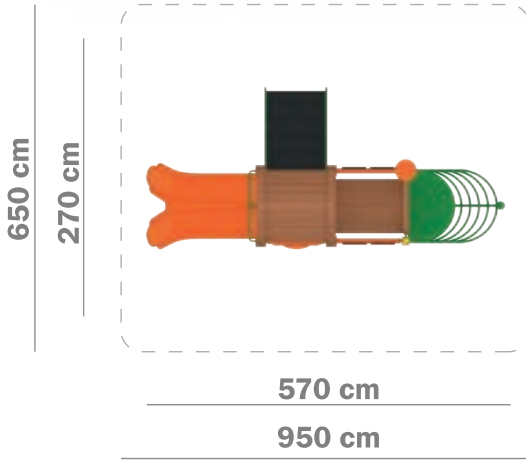

6  
Kişi

Kapasite

5  
yaş +

Yaş Grubu

Ürün Kodu  
TOG - 01

- H:100 cm İKİLİ KAYDIRAK 1 ADET
- KARE PLATFORM 1 ADET
- MERDİVEN 1 ADET
- TREN ÇATI 1 ADET
- PANO 1 ADET

- TREN ALT PANO 3 ADET
- TÜNEL GEÇİŞ 1 ADET
- METAL TREN ÖNÜ 1 ADET





# TREN OYUN GRUPLARI



## TEKNİK ÖZELLİKLER

- SICAK DALDIRMA GALVANİZ TAŞIYICI
- METAL AKSAMLAR ELEKTROSTATİK TOZ BOYALI
- POLİETİLEN PLASTİK EKİPMANLAR

31



İrün Kodu  
**TOG - 02**

13  
Kişi

Kapasite

5  
yaş +

Yaş Grubu

- H:100 cm DÜZ KAYDIRAK 1 ADET
- H:100 cm İKİLİ KAYDIRAK 1 ADET
- KARE PLATFORM 2 ADET
- MERDİVEN 1 ADET
- TREN ÇATI 1 ADET
- PANO 2 ADET

- TREN ALT PANO 4 ADET
- TÜNEL GEÇİŞ 1 ADET
- METAL TREN ÖNÜ 1 ADET

900 cm

480 cm

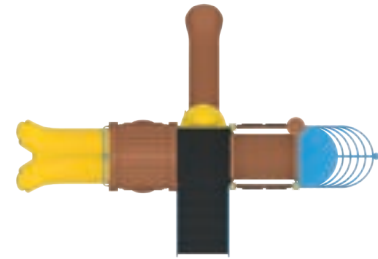

680 cm

1100 cm



**AHŞAP DÜNYASI**  
KENT MOBİLYALARI

www.ahsapdunyasi.com.tr

info@ahsapdunyasi.com.tr



## TEKNİK ÖZELLİKLER

- SICAK DALDIRMA GALVANİZ TAŞIYICI
- METAL AKSAMLAR ELEKTROSTATİK TOZ BOYALI
- POLİETİLEN PLASTİK EKİPMANLAR



32

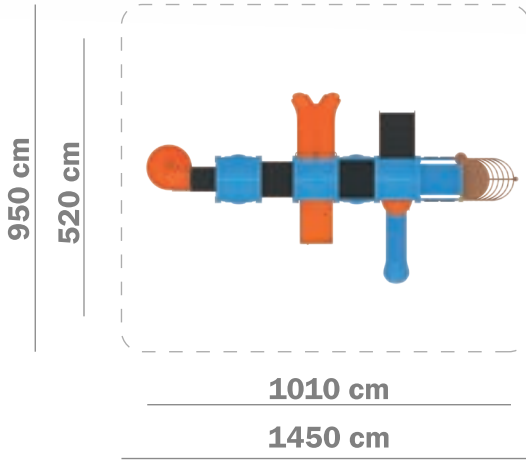

21  
Kişi

Kapasite

5  
yaş +

Yaş Grubu

Ürün Kodu  
TOG - 03

- H:200 cm HELEZON KAYDIRAK 1 ADET
- H:100 cm DÜZ KAYDIRAK 1 ADET
- H:100 cm İKİLİ KAYDIRAK 1 ADET
- KARE PLATFORM 3 ADET
- HELEZON PLATFORM 1 ADET
- MERDİVEN 2 ADET
- TREN ÇATI 3 ADET
- PANO 4 ADET
- TREN ALT PANO 6 ADET
- TÜNEL GEÇİŞ 1 ADET
- METAL TREN ÖNÜ 1 ADET
- KAYA TIRMANMA 1 ADET



# TREN OYUN GRUPLARI

## TEKNİK ÖZELLİKLER

- SICAK DALDIRMA GALVANİZ TAŞIYICI
- METAL AKSAMLAR ELEKTROSTATİK TOZ BOYALI
- POLİETİLEN PLASTİK EKİPMANLAR

33



Ürün Kodu  
**TOG - 04**

25  
Kişi

Kapasite

5  
yaş +

Yaş Grubu

- H:100 cm EĞRİ KAYDIRAK 1 ADET
- H:100 cm İKİLİ KAYDIRAK 1 ADET
- H:100 cm DALGALI 1 ADET
- H:100 cm TÜP 1 ADET
- KARE PLATFORM 5 ADET
- MERDİVEN 1 ADET
- TREN ÇATI 3 ADET

- PANO 4 ADET
- TREN ALT PANO 4 ADET
- TÜNEL GEÇİŞ 2 ADET
- METAL TREN ÖNÜ 2 ADET
- KAKTÜS TIRMANMA 1 ADET

1000 cm

570 cm

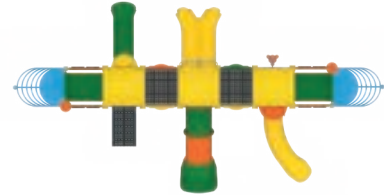

1100 cm

1500 cm



**AHŞAP DÜNYASI**  
KENT MOBİLYALARI

www.ahsapdunyasi.com.tr

info@ahsapdunyasi.com.tr





# TREN OYUN GRUPLARI

## TEKNİK ÖZELLİKLER

- SICAK DALDIRMA GALVANİZ TAŞIYICI
- METAL AKSAMLAR ELEKTROSTATİK TOZ BOYALI
- POLİETİLEN PLASTİK EKİPMANLAR



34

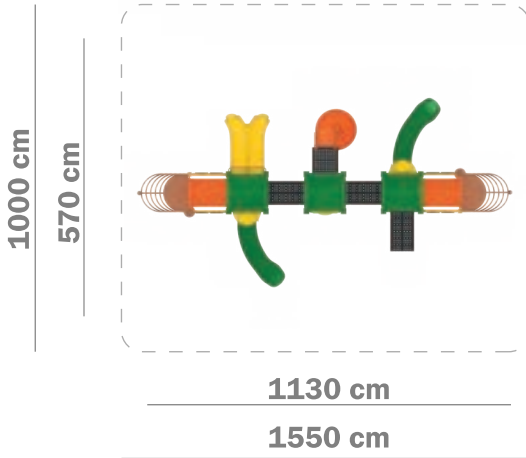

25  
Kişi

Kapasite

5  
yaş +

Yaş Grubu

Ürün Kodu  
TOG - 05

- H:200 cm HELEZON KAYDIRAK 1 ADET
- H:100 cm EĞRİ KAYDIRAK 2 ADET
- H:100 cm İKİLİ KAYDIRAK 1 ADET
- KARE PLATFORM 2 ADET
- HELEZON PLATFORM 1 ADET
- MERDİVEN 3 ADET
- TREN ÇATI 3 ADET
- PANO 1 ADET
- TREN ALT PANO 5 ADET
- TÜNEL GEÇİŞ 2 ADET
- METAL TREN ÖNÜ 2 ADET





# AHŞAP DÜNYASI

KENT MOBİLYALARI



*Gemi Oyun  
Grupları*



## TEKNİK ÖZELLİKLER

- SICAK DALDIRMA GALVANİZ TAŞIYICI
- METAL AKSAMLAR ELEKTROSTATİK TOZ BOYALI
- POLİETİLEN PLASTİK EKİPMANLAR



36

1150 cm

750 cm

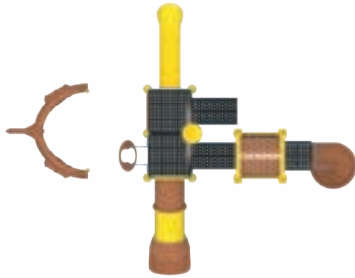

950 cm

1350 cm

28

Kişi

Kapasite

5

yaş +

Yaş Grubu

Ürün Kodu  
GOG - 01

- H:200 cm HELEZON KAYDIRAK 1 ADET
- H:100 cm DÜZ KAYDIRAK 1 ADET
- H:100 cm TÜP KAYDIRAK 1 ADET
- HELEZON PLATFORM 1 ADET
- KARE PLATFORM 2 ADET
- MERDİVEN 2 ADET
- GEMİ ÇATI 1 ADET
- PANO 3 ADET
- GEMİ ÖNÜ 1 ADET
- GEMİ DİREĞİ 1 ADET
- ELİPS TIRMANMA 1 ADET





# GEMİ OYUN GRUPLARI



## TEKNİK ÖZELLİKLER

- SICAK DALDIRMA GALVANİZ TAŞIYICI
- METAL AKSAMLAR ELEKTROSTATİK TOZ BOYALI
- POLİETİLEN PLASTİK EKİPMANLAR

37



Ürün Kodu  
**GOG - 02**

30  
Kişi

Kapasite

5  
yaş +

Yaş Grubu

- H:200 cm HELEZON KAYDIRAK 1 ADET
- H:200 cm DÜZ KAYDIRAK 1 ADET
- H:100 cm DALGALI KAYDIRAK 1 ADET
- H:100 cm EĞRİ KAYDIRAK 2 ADET
- HELEZON PLATFORM 1 ADET
- KARE PLATFORM 2 ADET
- MERDİVEN 2 ADET
- GEMİ ÇATI 1 ADET
- PANO 2 ADET
- GEMİ ÖNÜ 1 ADET
- KAYA TIRMANMA 1 ADET
- TEMATİK FİGÜR 2 ADET

1050 cm

650 cm

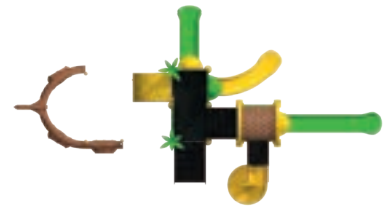

1150 cm

1500 cm



**AHŞAP DÜNYASI**  
KENT MOBİLYALARI

www.ahsapdunyasi.com.tr

info@ahsapdunyasi.com.tr



## TEKNİK ÖZELLİKLER

- SICAK DALDIRMA GALVANİZ TAŞIYICI
- METAL AKSAMLAR ELEKTROSTATİK TOZ BOYALI
- POLİETİLEN PLASTİK EKİPMANLAR



38

1050 cm

650 cm

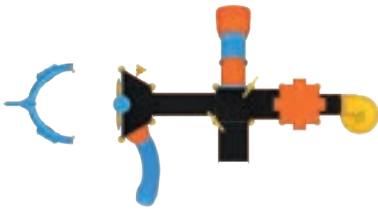

1200 cm

1600 cm

31

Kişi

Kapasite

5

yaş +

Yaş Grubu

Ürün Kodu  
GOG - 03

- H:200 cm HELEZON KAYDIRAK 1 ADET
- H:100 cm TÜP KAYDIRAK 1 ADET
- H:100 cm EĞRİ KAYDIRAK 1 ADET
- HELEZON PLATFORM 1 ADET
- KARE PLATFORM 1 ADET
- YARIM ALTIGEN PLATFORM 1 ADET
- MERDİVEN 2 ADET
- KARE ÇATI 1 ADET
- PANO 4 ADET
- GEMİ DİREĞİ 1 ADET
- GEMİ ÖNÜ 1 ADET
- KÖPRÜ 1 ADET
- KAKTÜS TIRMANMA 1 ADET
- TEMATİK FİĞÜR 2 ADET



# GEMİ OYUN GRUPLARI



## TEKNİK ÖZELLİKLER

- SICAK DALDIRMA GALVANİZ TAŞIYICI
- METAL AKSAMLAR ELEKTROSTATİK TOZ BOYALI
- POLİETİLEN PLASTİK EKİPMANLAR

39



Ürün Kodu  
**GOG - 04**

40  
Kişi

Kapasite

5  
yaş +

Yaş Grubu

- H:100 cm DÜZ KAYDIRAK 1 ADET
- H:100 cm İKİLİ KAYDIRAK 1 ADET
- H:100 cm TÜP KAYDIRAK 1 ADET
- H:100 cm EĞRİ KAYDIRAK 1 ADET
- ALTİGEN PLATFORM 1 ADET
- YARIM ALTİGEN PLATFORM 1 ADET

- MERDİVEN 1 ADET
- ALTİGEN ÇATI 1 ADET
- PANO 3 ADET
- GEMİ DİREĞİ 1 ADET
- GEMİ ÖNÜ 2 ADET
- KOMANDO MERDİVEN 1 ADET
- KÖPRÜ 1 ADET

1050 cm

650 cm



1550 cm

1850 cm



**AHŞAP DÜNYASI**  
KENT MOBİLYALARI

[www.ahsapdunyasi.com.tr](http://www.ahsapdunyasi.com.tr)

[info@ahsapdunyasi.com.tr](mailto:info@ahsapdunyasi.com.tr)





## TEKNİK ÖZELLİKLER

- SICAK DALDIRMA GALVANİZ TAŞIYICI
- METAL AKSAMLAR ELEKTROSTATİK TOZ BOYALI
- POLİETİLEN PLASTİK EKİPMANLAR



40

1150 cm

750 cm

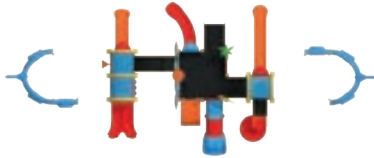

1750 cm

2100 cm

52

Kişi

Kapasite

5

yaş +

Yaş Grubu

Ürün Kodu  
GOG - 05

- H:200 cm HELEZON KAYDIRAK 1 ADET
- H:200 cm DÜZ KAYDIRAK 1 ADET
- H:100 cm DALGALI KAYDIRAK 1 ADET
- H:100 cm EĞRİ KAYDIRAK 1 ADET
- H:100 cm İKİLİ KAYDIRAK 1 ADET
- H:100 cm TÜP KAYDIRAK 1 ADET
- HELEZON PLATFORM 1 ADET
- KARE PLATFORM 6 ADET
- MERDİVEN 2 ADET
- GEMİ ÇATI 3 ADET
- PANO 3 ADET
- TİKTAK PANO 2 ADET
- GEMİ ÖNÜ 2 ADET
- GEMİ DİREĞİ 1 ADET
- KAKTÜS TIRMANMA 1 ADET
- KAYA TIRMANMA 1 ADET
- TEMATİK FİĞÜR 2 ADET
- KÖPRÜ 1 ADET





# AHŞAP DÜNYASI

KENT MOBİLYALARI



*Eko Oyun  
Grupları*



## TEKNİK ÖZELLİKLER

- SICAK DALDIRMA GALVANİZ TAŞIYICI
- METAL AKSAMLAR ELEKTROSTATİK TOZ BOYALI
- POLİETİLEN PLASTİK EKİPMANLAR
- SICAK DALDIRMA GALVANİZ ZİNCİR



42

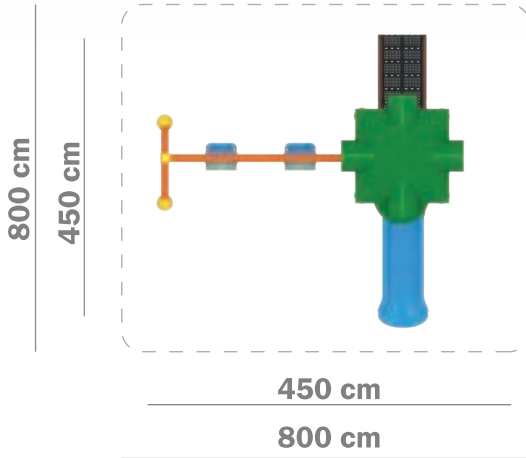

8  
Kişi

Kapasite

5  
yaş +

Yaş Grubu

Ürün Kodu  
EOG - 01

- H:100 cm DALGALI KAYDIRAK 1 ADET
- KARE PLATFORM 1 ADET
- MERDİVEN 1 ADET
- KARE ÇATI 1 ADET
- PANO 2 ADET
- SALINCAK 1 ADET





## TEKNİK ÖZELLİKLER

- SICAK DALDIRMA GALVANİZ TAŞIYICI
- METAL AKSAMLAR ELEKTROSTATİK TOZ BOYALI
- POLİETİLEN PLASTİK EKİPMANLAR

43



Ürün Kodu  
**EOG - 02**

17  
Kişi

Kapasite

5  
yaş +

Yaş Grubu

- H:200 cm HELEZON KAYDIRAK 1 ADET
- H:100 cm İKİLİ KAYDIRAK 1 ADET
- H:100 cm TÜP KAYDIRAK 1 ADET
- KARE PLATFORM 2 ADET
- HELEZON PLATFORM 1 ADET
- MERDİVEN 2 ADET
- KARE ÇATI 1 ADET
- PANO 3 ADET
- KAKTÜS TIRMANMA 1 ADET
- TÜNEL GEÇİŞ 1 ADET

950 cm

550 cm

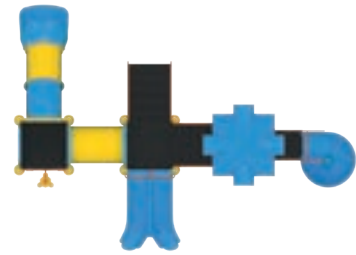

800 cm

1150 cm



**AHSAP DÜNYASI**  
KENT MOBİLYALARI

www.ahsapdunyasi.com.tr

info@ahsapdunyasi.com.tr



## TEKNİK ÖZELLİKLER

- SICAK DALDIRMA GALVANİZ TAŞIYICI
- METAL AKSAMLAR ELEKTROSTATİK TOZ BOYALI
- POLİETİLEN PLASTİK EKİPMANLAR



44

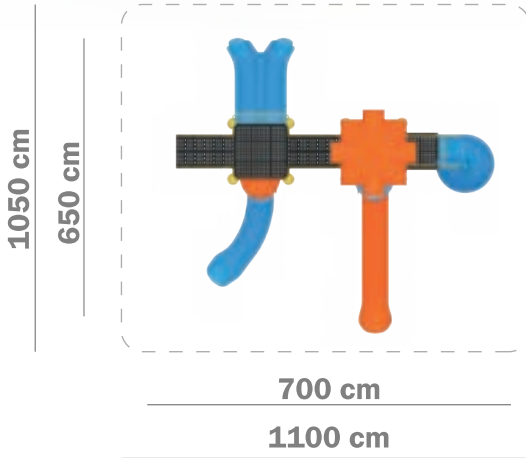

18

Kişi

Kapasite

5

yaş +

Yaş Grubu

Ürün Kodu  
EOG - 03

- H:200cm HELEZON KAYDIRAK 1 ADET
- H:200 cm DÜZ KAYDIRAK 1 ADET
- H:100 cm EĞRİ KAYDIRAK 1 ADET
- H:100 cm İKİLİ KAYDIRAK 1 ADET
- KARE PLATFORM 1 ADET
- HELEZON PLATFORM 1 ADET
- MERDİVEN 2 ADET
- KARE ÇATI 1 ADET
- PANO 1 ADET





## TEKNİK ÖZELLİKLER

- SICAK DALDIRMA GALVANİZ TAŞIYICI
- METAL AKSAMLAR ELEKTROSTATİK TOZ BOYALI
- POLİETİLEN PLASTİK EKİPMANLAR
- SICAK DALDIRMA GALVANİZ ZİNCİR

45



Ürün Kodu  
**EOG - 04**

**18**  
Kişi

Kapasite

**5**  
yaş +

Yaş Grubu

- H:200 cm HELEZON KAYDIRAK 1 ADET
- H:100 cm DALGALI KAYDIRAK 1 ADET
- KARE PLATFORM 1 ADET
- HELEZON PLATFORM 1 ADET
- MERDİVEN 2 ADET
- KONİK ÇATI 1 ADET
- PANO 3 ADET
- SALINCAK 1 ADET
- TEMATİK FİĞÜR 2 ADET

1050 cm

650 cm

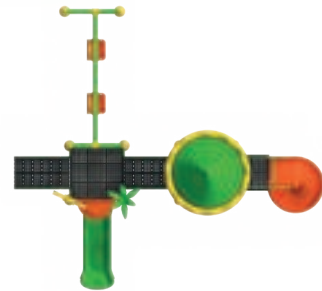

700 cm

1100 cm



**AHSAP DÜNYASI**  
KENT MOBİLYALARI

www.ahsapdunyasi.com.tr

info@ahsapdunyasi.com.tr





## TEKNİK ÖZELLİKLER

- SICAK DALDIRMA GALVANİZ TAŞIYICI
- METAL AKSAMLAR ELEKTROSTATİK TOZ BOYALI
- POLİETİLEN PLASTİK EKİPMANLAR



46

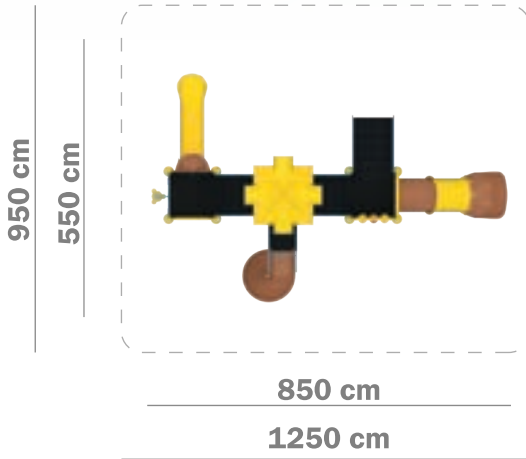

18  
Kişi

Kapasite

5  
yaş +

Yaş Grubu

Ürün Kodu  
EOG - 05

- H:200 cm HELEZON KAYDIRAK 1 ADET
- H:100 cm DÜZ KAYDIRAK 1 ADET
- H:100 cm TÜP KAYDIRAK 1 ADET
- KARE PLATFORM 2 ADET
- HELEZON PLATFORM 1 ADET
- MERDİVEN 3 ADET
- KARE ÇATI 1 ADET
- PANO 2 ADET
- TİKTAK PANO 1 ADET
- KAKTÜS TIRMANMA 1 ADET





## TEKNİK ÖZELLİKLER

- SICAK DALDIRMA GALVANİZ TAŞIYICI
- METAL AKSAMLAR ELEKTROSTATİK TOZ BOYALI
- POLİETİLEN PLASTİK EKİPMANLAR

47



Ürün Kodu  
**EOG - 06**

19  
Kişi

Kapasite

5  
yaş +

Yaş Grubu

- H:100 cm DALGALI KAYDIRAK 1 ADET
- H:100 cm İKİLİ KAYDIRAK 1 ADET
- H:100 cm DÜZ KAYDIRAK 1 ADET
- KARE PLATFORM 2 ADET
- MERDİVEN 1 ADET
- KARE ÇATI 1 ADET
- KAYA TIRMANMA 1 ADET
- KÖPRÜ 1 ADET
- YATAY MERDİVEN 1 ADET
- TEMATİK FİGÜR 1 ADET

950 cm

550 cm

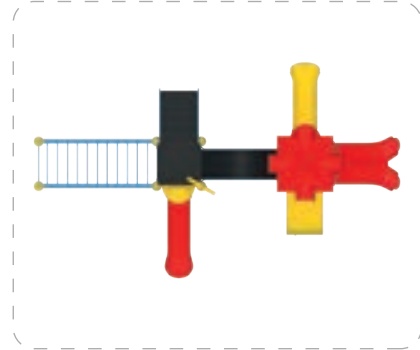

900 cm

1250 cm



**AHŞAP DÜNYASI**  
KENT MOBİLYALARI

www.ahsapdunyasi.com.tr

info@ahsapdunyasi.com.tr



## TEKNİK ÖZELLİKLER

- SICAK DALDIRMA GALVANİZ TAŞIYICI
- METAL AKSAMLAR ELEKTROSTATİK TOZ BOYALI
- POLİETİLEN PLASTİK EKİPMANLAR



48

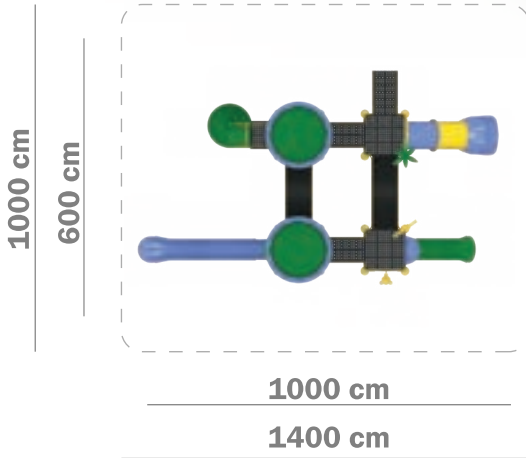

24  
Kişi

Kapasite

5  
yaş +

Yaş Grubu

Ürün Kodu  
EOG - 07

- H:200 cm HELEZON KAYDIRAK 1 ADET
- H:200 cm DALGALI KAYDIRAK 1 ADET
- H:100 cm DALGALI KAYDIRAK 1 ADET
- H:100 cm TÜP KAYDIRAK 1 ADET
- KARE PLATFORM 3 ADET
- HELEZON PLATFORM 1 ADET
- MERDİVEN 3 ADET
- KONİK ÇATI 2 ADET
- KÖPRÜ 2 ADET
- PANO 2 ADET
- KAKTÜS TIRMANMA 1 ADET
- TEMATİK FİGÜR 2 ADET







## TEKNİK ÖZELLİKLER

- SICAK DALDIRMA GALVANİZ TAŞIYICI
- METAL AKSAMLAR ELEKTROSTATİK TOZ BOYALI
- POLİETİLEN PLASTİK EKİPMANLAR

49



Ürün Kodu  
**EOG - 08**

24  
Kişi

Kapasite

5  
yaş +

Yaş Grubu

- H:100 cm DÜZ KAYDIRAK 1 ADET
- H:100 cm İKİLİ KAYDIRAK 1 ADET
- H:100 cm TÜP KAYDIRAK 1 ADET
- H:100 cm EĞRİ KAYDIRAK 2 ADET
- KARE PLATFORM 2 ADET
- ALTİGEN PLATFORM 1 ADET

- TÜNEL GEÇİŞ 2 ADET
- MERDİVEN 1 ADET
- ALTİGEN ÇATI 1 ADET
- PANO 2 ADET
- KAYA TIRMANMA 1 ADET
- TİKTAK PANO 1 ADET
- TEMATİK FİGÜR 2 ADET

1050 cm

650 cm

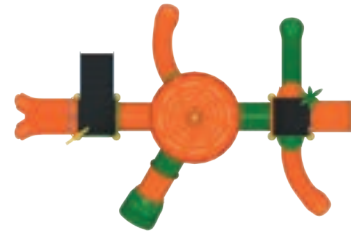

950 cm

1350 cm



**AHŞAP DÜNYASI**  
KENT MOBİLYALARI

www.ahsapdunyasi.com.tr

info@ahsapdunyasi.com.tr



## TEKNİK ÖZELLİKLER

- SICAK DALDIRMA GALVANİZ TAŞIYICI
- METAL AKSAMLAR ELEKTROSTATİK TOZ BOYALI
- POLİETİLEN PLASTİK EKİPMANLAR



50

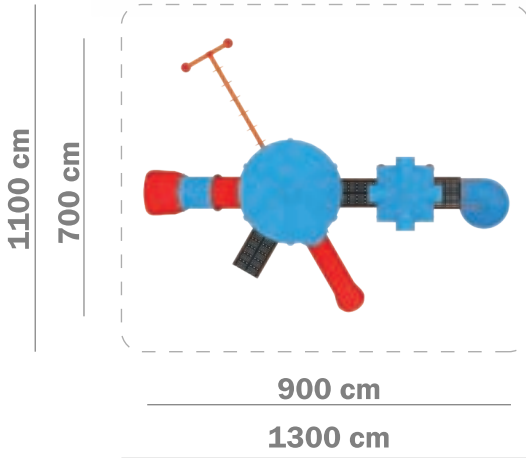

25  
Kişi

Kapasite

5  
yaş +

Yaş Grubu

Ürün Kodu  
EOG - 09

- H:200 cm HELEZON KAYDIRAK 1 ADET
- H:100 cm DÜZ KAYDIRAK 1 ADET
- H:100 cm TÜP KAYDIRAK 1 ADET
- ALTİGEN PLATFORM 1 ADET
- HELEZON PLATFORM 1 ADET
- MERDİVEN 2 ADET
- KARE ÇATI 1 ADET
- ALTİGEN ÇATI 1 ADET
- PANO 3 ADET
- KOMANDO MERDİVEN 1 ADET





## TEKNİK ÖZELLİKLER

- SICAK DALDIRMA GALVANİZ TAŞIYICI
- METAL AKSAMLAR ELEKTROSTATİK TOZ BOYALI
- POLİETİLEN PLASTİK EKİPMANLAR

51



Ürün Kodu  
**EOG - 10**

28  
Kişi

Kapasite

5  
yaş +

Yaş Grubu

- H:200 cm HELEZON KAYDIRAK 1 ADET
- H:200 cm DÜZ KAYDIRAK 1 ADET
- H:100 cm İKİLİ KAYDIRAK 1 ADET
- H:100 cm EĞRİ KAYDIRAK 2 ADET
- KARE PLATFORM 3 ADET
- HELEZON PLATFORM 1 ADET
- MERDİVEN 3 ADET
- KONİK ÇATI 1 ADET
- PANO 3 ADET
- KAYA TIRMANMA 1 ADET
- TEMATİK FIGÜR 2 ADET

1200 cm

800 cm

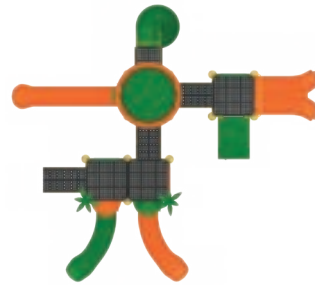

900 cm

1300 cm



**AHSAP DÜNYASI**  
KENT MOBİLYALARI

[www.ahsapdunyasi.com.tr](http://www.ahsapdunyasi.com.tr)

[info@ahsapdunyasi.com.tr](mailto:info@ahsapdunyasi.com.tr)





## TEKNİK ÖZELLİKLER

- SICAK DALDIRMA GALVANİZ TAŞIYICI
- METAL AKSAMLAR ELEKTROSTATİK TOZ BOYALI
- POLİETİLEN PLASTİK EKİPMANLAR



52

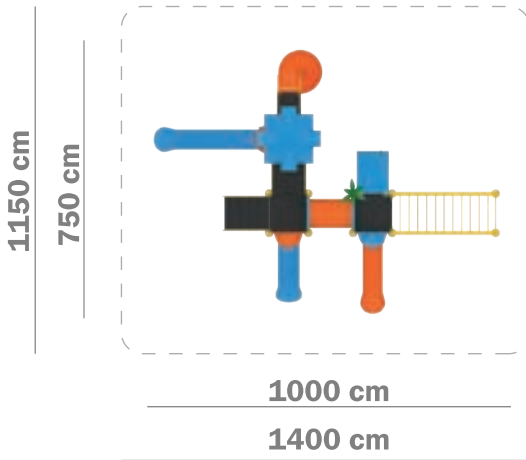

30  
Kişi

Kapasite

5  
yaş +

Yaş Grubu

Ürün Kodu  
EOG - 11

- H:200 cm HELEZON KAYDIRAK 1 ADET
- H:200 cm DÜZ KAYDIRAK 1 ADET
- H:100 cm DALGALI KAYDIRAK 1 ADET
- H:100 cm DÜZ KAYDIRAK 1 ADET
- KARE PLATFORM 2 ADET
- HELEZON PLATFORM 1 ADET
- MERDİVEN 2 ADET
- KARE ÇATI 1 ADET
- KAYA TIRMANMA 1 ADET
- TÜNEL GEÇİŞ 1 ADET
- YATAY MERDİVEN 1 ADET
- TEMATİK FİGÜR 1 ADET
- PANO 1 ADET



## TEKNİK ÖZELLİKLER

- SICAK DALDIRMA GALVANİZ TAŞIYICI
- METAL AKSAMLAR ELEKTROSTATİK TOZ BOYALI
- POLİETİLEN PLASTİK EKİPMANLAR

53



Ürün Kodu  
EOG - 12

30  
Kişi

Kapasite

5  
yaş +

Yaş Grubu

- H:200 cm HELEZON KAYDIRAK 1 ADET
- H:100 cm DÜZ KAYDIRAK 1 ADET
- H:100 cm İKİLİ KAYDIRAK 1 ADET
- H:100 cm TÜP KAYDIRAK 1 ADET
- KARE PLATFORM 1 ADET
- HELEZON PLATFORM 1 ADET
- ALTİGEN PLATFORM 1 ADET
- KÖPRÜ 1 ADET
- MERDİVEN 2 ADET
- KONİK ÇATI 1 ADET
- ALTİGEN ÇATI 1 ADET
- PANO 4 ADET
- KOMANDO MERDİVEN 1 ADET

1250 cm

850 cm



900 cm

1300 cm



**AHSAP DÜNYASI**  
KENT MOBİLYALARI

www.ahsapdunyasi.com.tr

info@ahsapdunyasi.com.tr



## TEKNİK ÖZELLİKLER

- SICAK DALDIRMA GALVANİZ TAŞIYICI
- METAL AKSAMLAR ELEKTROSTATİK TOZ BOYALI
- POLİETİLEN PLASTİK EKİPMANLAR



54

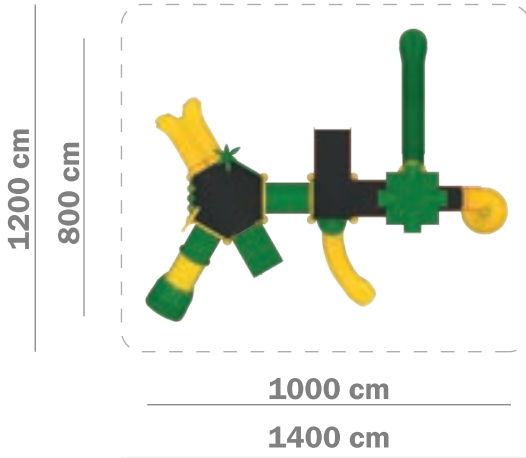

32  
Kişi

Kapasite

5  
yaş +

Yaş Grubu

Ürün Kodu  
EOG - 13

- H:200 cm HELEZON KAYDIRAK 1 ADET
- H:200 cm DALGALI KAYDIRAK 1 ADET
- H:100 cm İKİLİ KAYDIRAK 1 ADET
- H:100 cm TÜP KAYDIRAK 1 ADET
- H:100 cm EĞRİ KAYDIRAK 1 ADET
- KARE PLATFORM 1 ADET
- HELEZON PLATFORM 1 ADET
- ALTİGEN PLATFORM 1 ADET
- MERDİVEN 2 ADET
- KARE ÇATI 1 ADET
- PANO 2 ADET
- KAYA TIRMANMA 1 ADET
- TÜNEL GEÇİŞ 1 ADET
- TIKTAK PANO 1 ADET
- TEMATİK FİGÜR 2 ADET





## TEKNİK ÖZELLİKLER

- SICAK DALDIRMA GALVANİZ TAŞIYICI
- METAL AKSAMLAR ELEKTROSTATİK TOZ BOYALI
- POLİETİLEN PLASTİK EKİPMANLAR

55



Ürün Kodu  
EOG - 14

32  
Kişi

Kapasite

5  
yaş +

Yaş Grubu

- H:200 cm HELEZON KAYDIRAK 1 ADET
- H:200 cm DALGALI KAYDIRAK 1 ADET
- H:100 cm DALGALI KAYDIRAK 1 ADET
- H:100 cm TÜP KAYDIRAK 1 ADET
- KARE PLATFORM 3 ADET
- HELEZON PLATFORM 1 ADET
- MERDİVEN 3 ADET
- KONİK ÇATI 2 ADET
- KÖPRÜ 1 ADET
- PANO 3 ADET
- TİKTAK PANO 1 ADET
- KAYA TIRMANMA 1 ADET
- TEMATİK FİĞÜR 2 ADET

1200 cm

800 cm

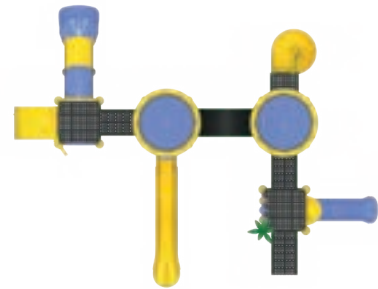

1000 cm

1400 cm



**AHŞAP DÜNYASI**  
KENT MOBİLYALARI

www.ahsapdunyasi.com.tr

info@ahsapdunyasi.com.tr



## TEKNİK ÖZELLİKLER

- SICAK DALDIRMA GALVANİZ TAŞIYICI
- METAL AKSAMLAR ELEKTROSTATİK TOZ BOYALI
- POLİETİLEN PLASTİK EKİPMANLAR



56

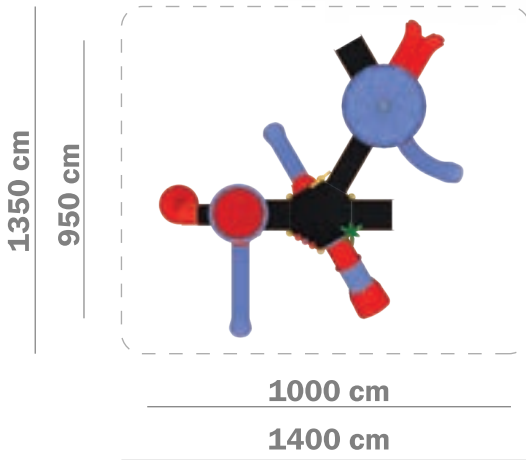

38  
Kişi

Kapasite

5  
yaş +

Yaş Grubu

Ürün Kodu  
EOG - 15

- H:200 cm HELEZON KAYDIRAK 1 ADET
- H:200 cm DÜZ KAYDIRAK 1 ADET
- H:100 cm DÜZ KAYDIRAK 1 ADET
- H:100 cm İKİLİ KAYDIRAK 1 ADET
- H:100 cm TÜP KAYDIRAK 1 ADET
- H:100 cm EĞRİ KAYDIRAK 2 ADET
- HELEZON PLATFORM 1 ADET
- ALTİGEN PLATFORM 2 ADET
- KÖPRÜ 1 ADET
- MERDİVEN 3 ADET
- KONİK ÇATI 1 ADET
- ALTİGEN ÇATI 1 ADET
- PANO 3 ADET
- TIKTAK PANO 1 ADET
- TEMATİK FİGÜR 2 ADET







# AHŞAP DÜNYASI

KENT MOBİLYALARI



*Engelsiz Oyun  
Grupları*



## TEKNİK ÖZELLİKLER

- SICAK DALDIRMA GALVANİZ TAŞIYICI
- METAL AKSAMLAR ELEKTROSTATİK TOZ BOYALI
- POLİETİLEN PLASTİK EKİPMANLAR



58

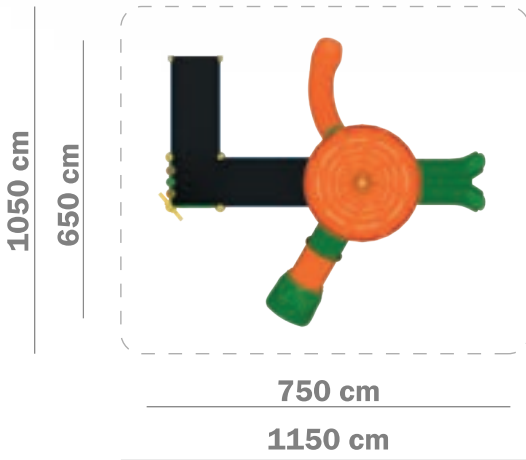

12  
Kişi

Kapasite

5  
yaş +

Yaş Grubu

Ürün Kodu  
ENG - 01

- H:100 cm İKİLİ KAYDIRAK 1 ADET
- H:100 cm TÜP KAYDIRAK 1 ADET
- H:100 cm EĞRİ KAYDIRAK 1 ADET
- KARE PLATFORM 1 ADET
- ALTIGEN PLATFORM 1 ADET
- ALTIGEN ÇATI 1 ADET

- H:50 cm RAMPA 2 ADET
- PANO 3 ADET
- TİKTAK PANO 1 ADET
- TEMATİK FİĞÜR 1 ADET



# ENGELSİZ OYUN GRUPLARI



## TEKNİK ÖZELLİKLER

- SICAK DALDIRMA GALVANİZ TAŞIYICI
- METAL AKSAMLAR ELEKTROSTATİK TOZ BOYALI
- POLİETİLEN PLASTİK EKİPMANLAR

59



Ürün Kodu  
**ENG - 02**

13  
Kişi

Kapasite

5  
yaş +

Yaş Grubu

- H:100 cm İKİLİ KAYDIRAK 1 ADET
- H:100 cm TÜP KAYDIRAK 1 ADET
- H:100 cm DÜZ KAYDIRAK 1 ADET
- KARE PLATFORM 2 ADET
- ALTİGEN PLATFORM 1 ADET

- ALTİGEN ÇATI 1 ADET
- H:50 cm RAMPA 4 ADET
- MERDİVEN 1 ADET
- PANO 4 ADET
- TEMATİK FİGÜR 2 ADET

1000 cm

600 cm

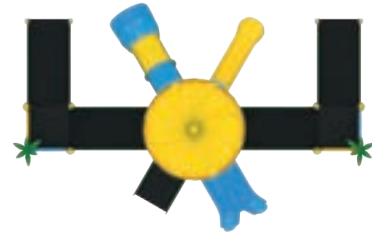

900 cm

1300 cm



**AHSAP DÜNYASI**  
KENT MOBİLYALARI

[www.ahsapdunyasi.com.tr](http://www.ahsapdunyasi.com.tr)

[info@ahsapdunyasi.com.tr](mailto:info@ahsapdunyasi.com.tr)



## TEKNİK ÖZELLİKLER

- SICAK DALDIRMA GALVANİZ TAŞIYICI
- METAL AKSAMLAR ELEKTROSTATİK TOZ BOYALI
- POLİETİLEN PLASTİK EKİPMANLAR



60

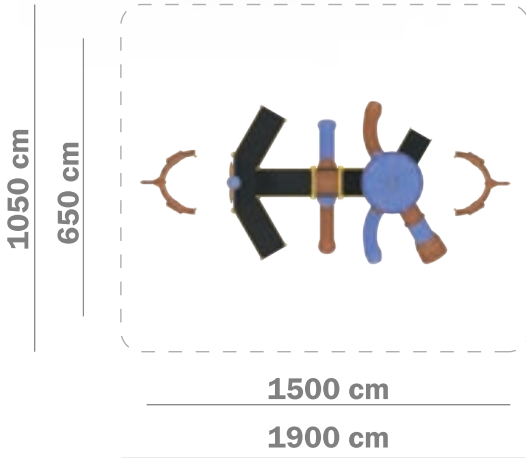

24  
Kişi

Kapasite

5  
yaş +

Yaş Grubu

Ürün Kodu  
ENG - 03

- H:100 cm DALGALI KAYDIRAK 1 ADET
- H:100 cm TÜP KAYDIRAK 1 ADET
- H:100 cm DÜZ KAYDIRAK 1 ADET
- H:100 cm EĞRİ KAYDIRAK 2 ADET
- KARE PLATFORM 2 ADET
- ALTİGEN PLATFORM 1 ADET
- YARIM ALTİGEN PLATFORM 1 ADET
- ALTİGEN ÇATI 1 ADET
- GEMİ ÇATI 1 ADET

- GEMİ DİREĞİ 1 ADET
- H:50 cm RAMPA 3 ADET
- MERDİVEN 1 ADET
- PANO 4 ADET
- TİK TAK PANO 1 ADET
- GEMİ ÖNÜ 2 ADET







## TEKNİK ÖZELLİKLER

- SICAK DALDIRMA GALVANİZ TAŞIYICI
- METAL AKSAMLAR ELEKTROSTATİK TOZ BOYALI
- POLİETİLEN PLASTİK EKİPMANLAR

61



Ürün Kodu  
**ENG - 04**

30  
Kişi

Kapasite

5  
yaş +

Yaş Grubu

- H:200 cm HELEZON KAYDIRAK 1 ADET
- H:100 cm DALGALI KAYDIRAK 1 ADET
- H:100 cm İKİLİ KAYDIRAK 1 ADET
- H:100 cm TÜP KAYDIRAK 1 ADET
- KARE PLATFORM 1 ADET
- HELEZON PLATFORM 1 ADET
- ALTİGEN PLATFORM 1 ADET
- KARE ÇATI 1 ADET
- H:50 cm RAMPA 2 ADET
- MERDİVEN 2 ADET
- PANO 3 ADET
- TİK TAK PANO 1 ADET

1050 cm

650 cm



1150 cm

1550 cm



**AHŞAP DÜNYASI**  
KENT MOBİLYALARI

www.ahsapdunyasi.com.tr

info@ahsapdunyasi.com.tr



## TEKNİK ÖZELLİKLER

- SICAK DALDIRMA GALVANİZ TAŞIYICI
- METAL AKSAMLAR ELEKTROSTATİK TOZ BOYALI
- POLİETİLEN PLASTİK EKİPMANLAR



62

1550 cm

1150 cm

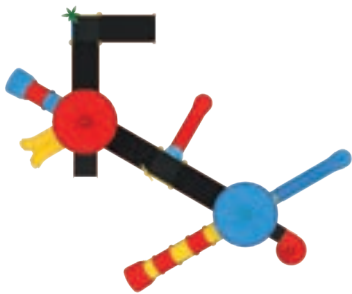

1400 cm

1800 cm

40  
Kişi

Kapasite

5  
yaş +

Yaş Grubu

Ürün Kodu  
ENG - 05

- H:200 cm DALGALI KAYDIRAK 1 ADET
- H:200 cm TÜP KAYDIRAK 1 ADET
- H:200 cm HELEZON KAYDIRAK 1 ADET
- H:150 cm DÜZ KAYDIRAK 1 ADET
- H:100 cm İKİLİ KAYDIRAK 1 ADET
- H:100 cm TÜP KAYDIRAK 1 ADET
- KARE PLATFORM 2 ADET
- HELEZON PLATFORM 1 ADET
- ALTİGEN PLATFORM 2 ADET
- ALTİGEN ÇATI 2 ADET
- H:50 cm RAMPA 4 ADET
- MERDİVEN 1 ADET
- PANO 5 ADET
- TİK TAK PANO 1 ADET
- TEMATİK FİGÜR 2 ADET







# AHŞAP DÜNYASI

KENT MOBİLYALARI



*Akasya Oyun  
Grupları*



## TEKNİK ÖZELLİKLER

- DİKMELER; AKASYA AĞACI
- HALAT; ÇELİK GÖBEKLİ-MULTİFLAMENT



64

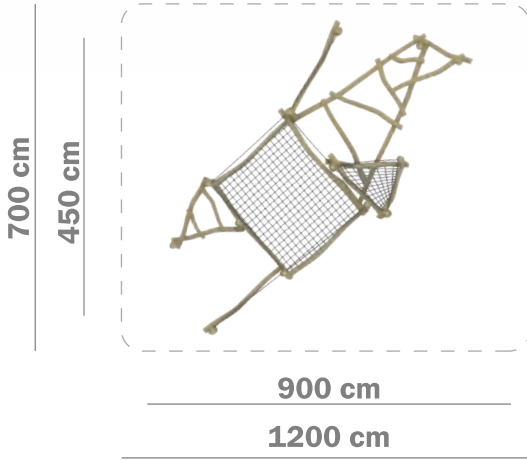

30  
Kişi

Kapasite

3  
yaş +

Yaş Grubu

Ürün Kodu  
AKS - 01



# AKASYA OYUN GRUPLARI

## TEKNİK ÖZELLİKLER

- DİKMELER; AKASYA AĞACI
- HALAT; ÇELİK GÖBEKLİ-MULTİFLAMENT
- KAYDIRAK PASLANMAZ 304 KALİTE

65



20

Kişi

Kapasite

3

yaş +

Yaş Grubu

Ürün Kodu  
AKS - 02

700 cm

450 cm

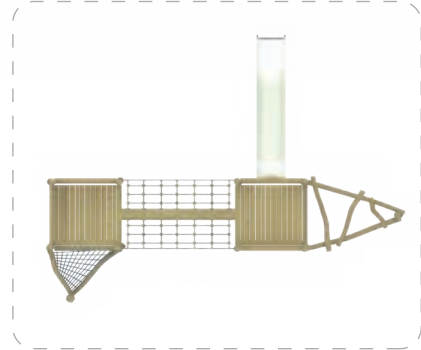

650 cm

900 cm



**AHŞAP DÜNYASI**  
KENT MOBİLYALARI

[www.ahsapdunyasi.com.tr](http://www.ahsapdunyasi.com.tr)

[info@ahsapdunyasi.com.tr](mailto:info@ahsapdunyasi.com.tr)



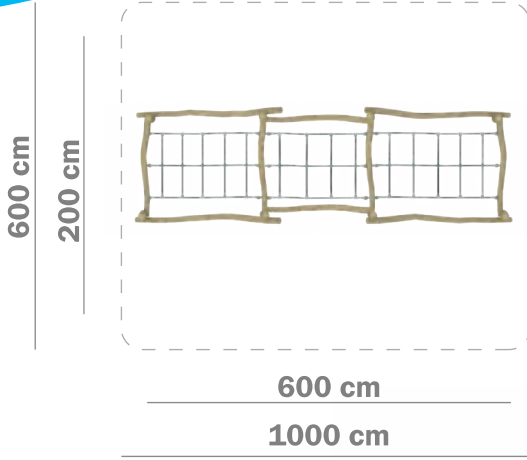

15  
Kişi

Kapasite

3  
yaş +

Yaş Grubu

Ürün Kodu  
AKS - 03

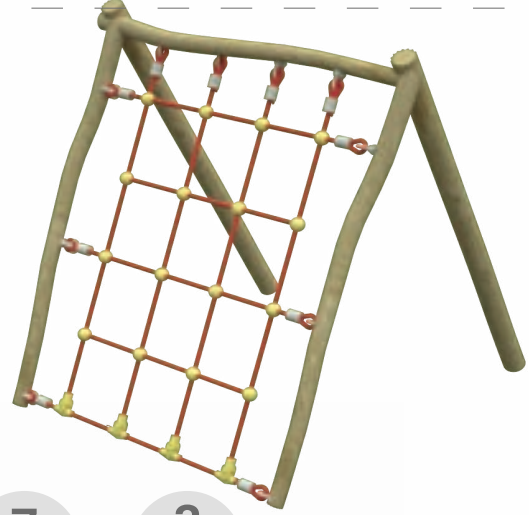
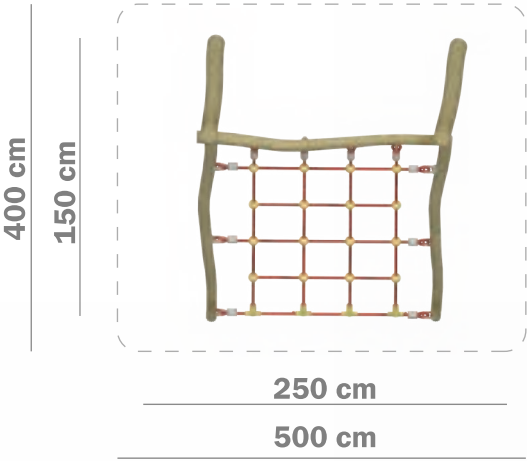

66

7  
Kişi

Kapasite

3  
yaş +

Yaş Grubu

Ürün Kodu  
AKS - 04



Ürün Kodu  
AKS - 05

800 cm

450 cm

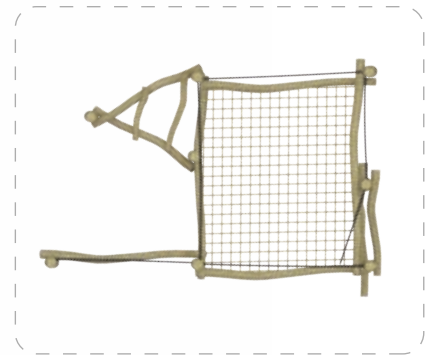

20  
Kişi

Kapasite

3  
yaş +

Yaş Grubu





# AKASYA OYUN GRUPLARI



450 cm

50 cm



300 cm

600 cm

5

Kişi

Kapasite

3

yaş +

Yaş Grubu

Ürün Kodu  
AKS - 06

67



200 cm

50 cm

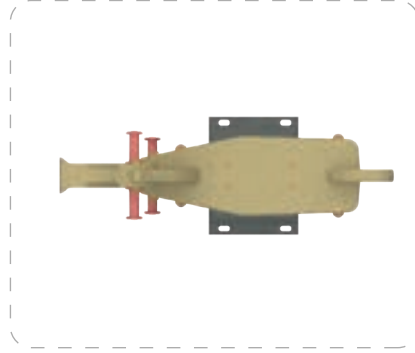

100 cm

350 cm

1

Kişi

Kapasite

3

yaş +

Yaş Grubu

Ürün Kodu  
AKS - 07



600 cm

300 cm

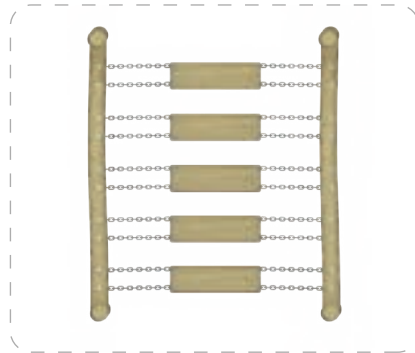

350 cm

700 cm

12

Kişi

Kapasite

3

yaş +

Yaş Grubu

Ürün Kodu  
AKS - 08



**AHŞAP DÜNYASI**  
KENT MOBİLYALARI

[www.ahsapdunyasi.com.tr](http://www.ahsapdunyasi.com.tr)

[info@ahsapdunyasi.com.tr](mailto:info@ahsapdunyasi.com.tr)





2  
Kişi  
Kapasite

3  
yaş +  
Yaş Grubu

Ürün Kodu  
AKS - 09

## TEKNİK ÖZELLİKLER

- DİKMELER; AKASYA AĞACI
- HALAT; ÇELİK GÖBEKLİ-MULTİFLAMENT
- SICAK DALDIRMA GALVANİZ ZİNCİR

280 cm  
170 cm

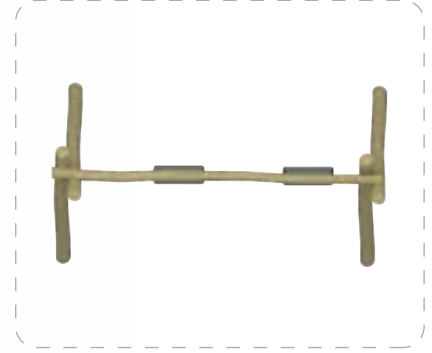

400 cm

600 cm

68



1  
Kişi  
Kapasite

3  
yaş +  
Yaş Grubu

Ürün Kodu  
AKS - 10

## TEKNİK ÖZELLİKLER

- DİKMELER; AKASYA AĞACI
- HALAT; ÇELİK GÖBEKLİ-MULTİFLAMENT
- SICAK DALDIRMA GALVANİZ ZİNCİR

200 cm  
150 cm

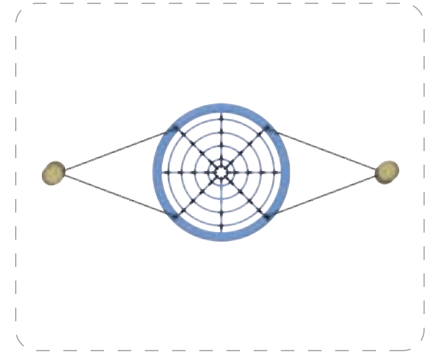

300 cm

500 cm





# AHŞAP DÜNYASI

KENT MOBİLYALARI



*Toki Oyun  
Grupları*



## TEKNİK ÖZELLİKLER

- SICAK DALDIRMA GALVANİZ TAŞIYICI
- METAL AKSAMLAR ELEKTROSTATİK TOZ BOYALI
- POLİETİLEN PLASTİK EKİPMANLAR

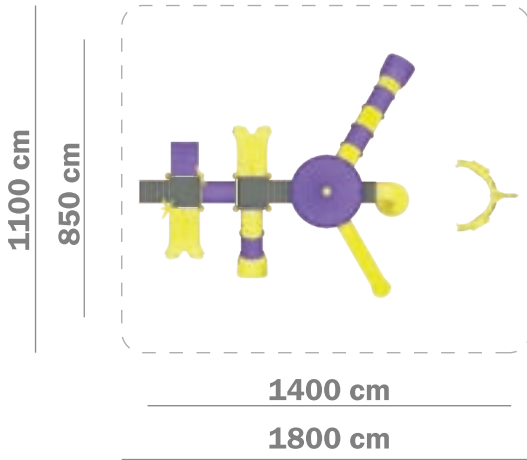

25  
Kişi

Kapasite

5  
yaş +

Yaş Grubu

Ürün Kodu  
TK - 01

- H:100 İKİZ KAYDIRAK 2 ADET
- H:100 TÜP KAYDIRAK 1 ADET
- H:200 TÜP KAYDIRAK 1 ADET
- H:200 HELEZON KAYDIRAK 1 ADET
- H:200 DÜZ KAYDIRAK 1 ADET
- GEMİ BURNU FİGÜRÜ 1 ADET

- BORU FİGÜRÜ 2 ADET
- TÜP GEÇİT 1 ADET
- KAYA TIRMANMA 1 ADET
- TİK TAK PANO 2 ADET





## TEKNİK ÖZELLİKLER

- SICAK DALDIRMA GALVANİZ TAŞIYICI
- METAL AKSAMLAR ELEKTROSTATİK TOZ BOYALI
- POLİETİLEN PLASTİK EKİPMANLAR

71



Ürün Kodu  
**TK - 02**

25  
Kişi

Kapasite

5  
yaş +

Yaş Grubu

- H:100 İKİZ KAYDIRAK 1 ADET
- H:150 İKİZ KAYDIRAK 1 ADET
- H:150 TÜP KAYDIRAK 1 ADET
- H:200 HELEZON KAYDIRAK 1 ADET
- H:200 DÜZ KAYDIRAK 1 ADET

- GEMİ BURNU FİGÜRÜ 1 ADET
- BORU FİGÜRÜ 2 ADET
- UFO TIRMANMA 2 ADET
- TİK TAK PANO 2 ADET

1000 cm

750 cm

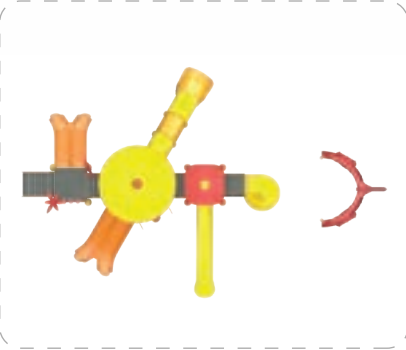

1200 cm

1500 cm



**AHSAP DÜNYASI**  
KENT MOBİLYALARI

## TEKNİK ÖZELLİKLER

- SICAK DALDIRMA GALVANİZ TAŞIYICI
- METAL AKSAMLAR ELEKTROSTATİK TOZ BOYALI
- POLİETİLEN PLASTİK EKİPMANLAR



72

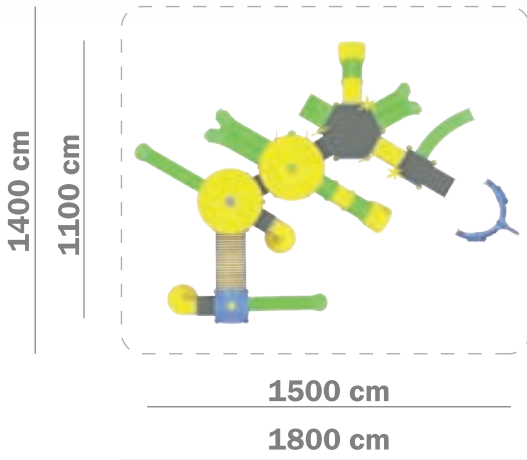

10  
Kişi

Kapasite

5  
yaş +

Yaş Grubu

Ürün Kodu  
TK - 03

- H:100 EĞRİ KAYDIRAK 1 ADET
- H:100 İKİZ KAYDIRAK 1 ADET
- H:100 TÜP KAYDIRAK 1 ADET
- H:150 İKİZ KAYDIRAK 1 ADET
- H:150 TÜP KAYDIRAK 2 ADET
- H:200 HELEZON KAYDIRAK 2 ADET
- H:200 DÜZ KAYDIRAK 2 ADET

- GEMİ BURNU FİGÜRÜ 1 ADET
- BORU FİGÜRÜ 4 ADET
- TÜP GEÇİT 1 ADET
- KÖPRÜ GEÇİŞİ 1 ADET
- KAYA TIRMANMA 1 ADET
- UFO TIRMANMA 1 ADET
- TİK TAK PANO 2 ADET







## TEKNİK ÖZELLİKLER

- SICAK DALDIRMA GALVANİZ TAŞIYICI
- METAL AKSAMLAR ELEKTROSTATİK TOZ BOYALI
- POLİETİLEN PLASTİK EKİPMANLAR

73



Ürün Kodu  
**TK - 04**

10  
Kişi

Kapasite

5  
yaş +

Yaş Grubu

- H:100 TÜP KAYDIRAK 1 ADET
- H:100 İKİZ KAYDIRAK 1 ADET
- H:150 TÜP KAYDIRAK 1 ADET
- H:150 HELEZON KAYDIRAK 1 ADET
- H:150 DÜZ KAYDIRAK 1 ADET

- GEMİ FİGÜRÜ 1 ADET
- BORU FİGÜRÜ 2 ADET
- TİK TAK PANO 1 ADET

1000 cm

750 cm

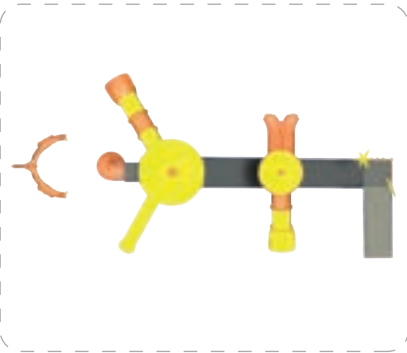

1500 cm

2000 cm



**AHŞAP DÜNYASI**  
KENT MOBİLYALARI

## TEKNİK ÖZELLİKLER

- SICAK DALDIRMA GALVANİZ TAŞIYICI
- METAL AKSAMLAR ELEKTROSTATİK TOZ BOYALI
- POLİETİLEN PLASTİK EKİPMANLAR



74

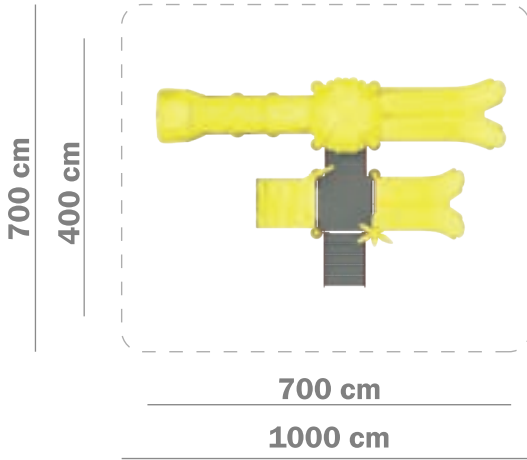

10  
Kişi

Kapasite

5  
yaş +

Yaş Grubu

Ürün Kodu  
TK - 05

- H:100 İKİZ KAYDIRAK 1 ADET
- H:150 İKİZ KAYDIRAK 1 ADET
- H:150 TÜP KAYDIRAK 1 ADET
- KAYA TIRMANMA 1 ADET
- BORU FİGÜRÜ 2 ADET







# AHSAP DÜNYASI

KENT MOBİLYALARI



*Ahsap Oyun  
Parkurları*



## TEKNİK ÖZELLİKLER

- 1. SINIF SARIÇAM
- VAKUMLU BASINÇLI EMPRENYE KORUMALI
- SUBAZLI AHŞAP BOYASI
- POLİETİLEN PLASTİK EKİPMANLAR
- SICAK DALDIRMA GALVANİZ ZİNCİR

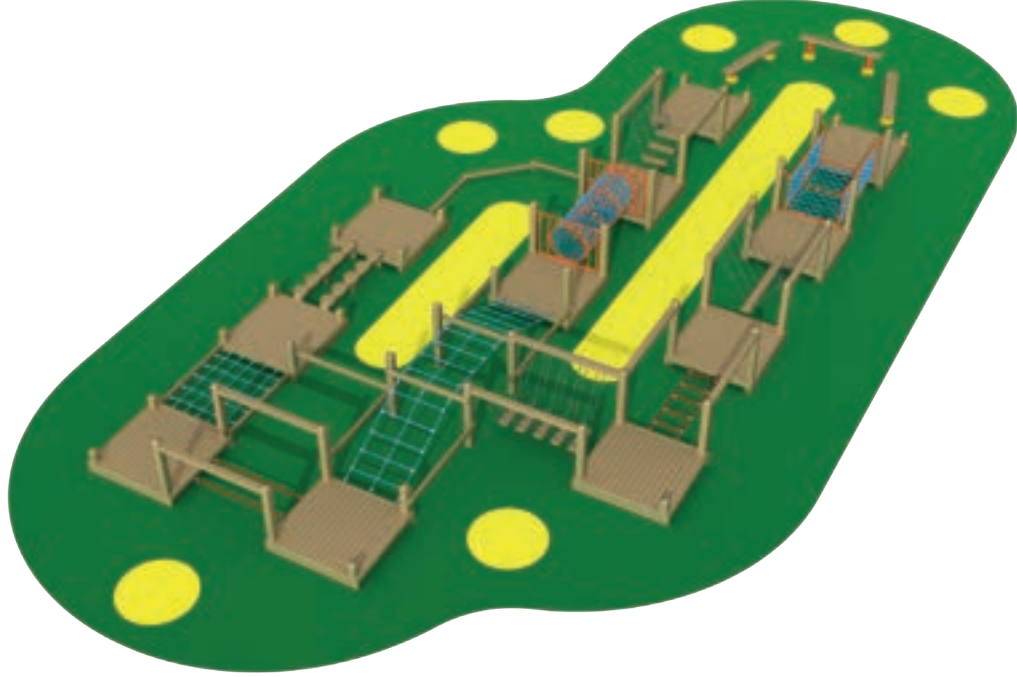
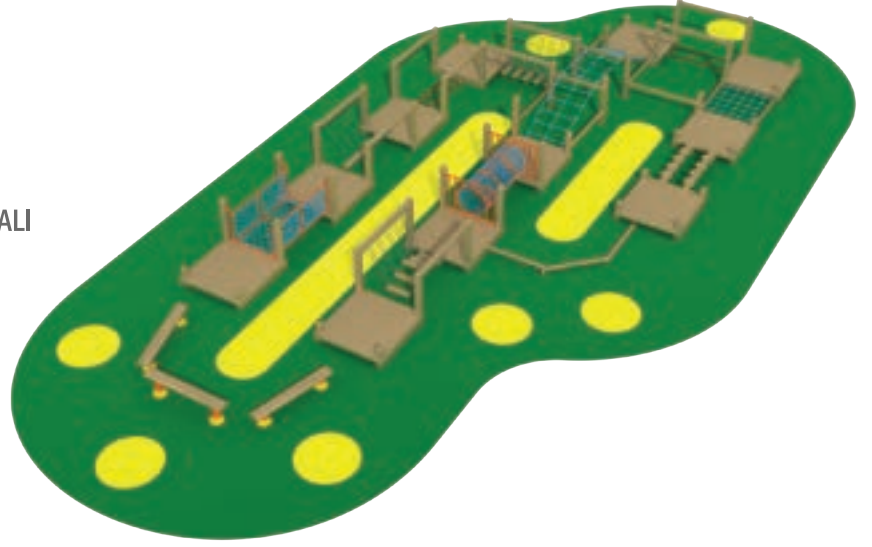

76

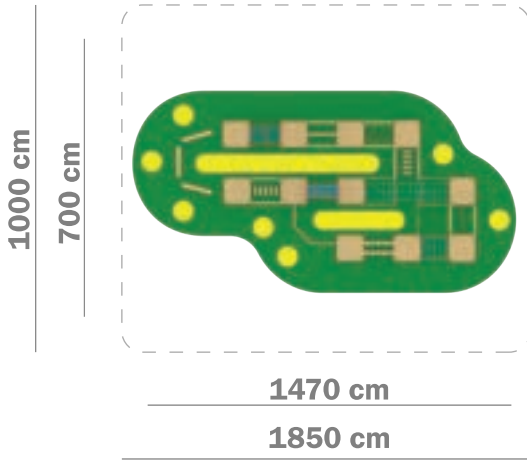

41

Kişi

Kapasite

5

yaş +

Yaş Grubu

Ürün Kodu  
AOP - 01





## TEKNİK ÖZELLİKLER

- 1. SINIF SARIÇAM
- VAKUMLU BASINÇLI EMPRENYE KORUMALI
- SUBAZLI AHŞAP BOYASI
- POLİETİLEN PLASTİK EKİPMANLAR
- SICAK DALDIRMA GALVANİZ ZİNCİR

77



Ürün Kodu  
**AOP - 02**

**74**  
Kişi  
Kapasite

**5**  
yaş +  
Yaş Grubu

1200 cm

850 cm

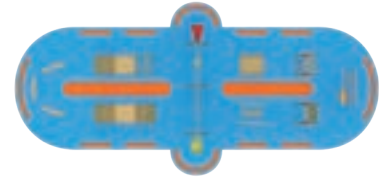

2200 cm

2500 cm



**AHŞAP DÜNYASI**  
KENT MOBİLYALARI



## TEKNİK ÖZELLİKLER

- 1. SINIF SARIÇAM
- VAKUMLU BASINÇLI EMPRENYE KORUMALI
- SUBAZLI AHŞAP BOYASI
- POLİETİLEN PLASTİK EKİPMANLAR
- SICAK DALDIRMA GALVANİZ ZİNCİR

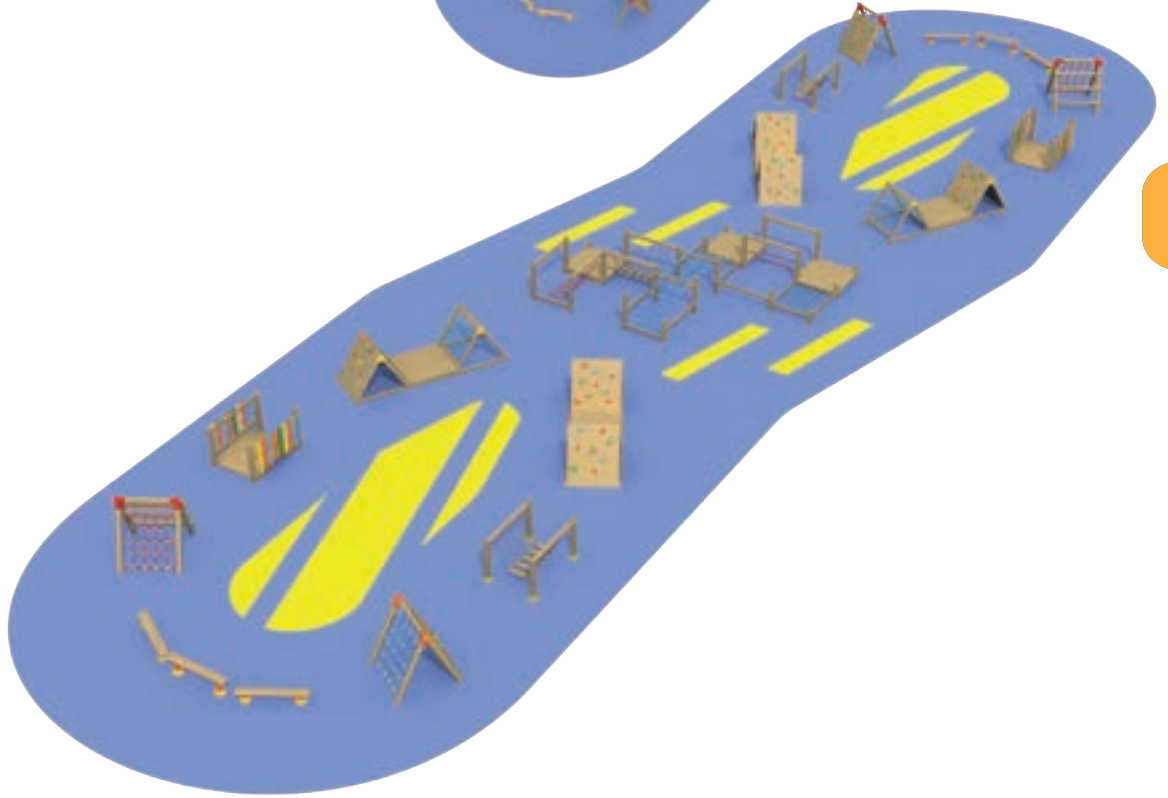
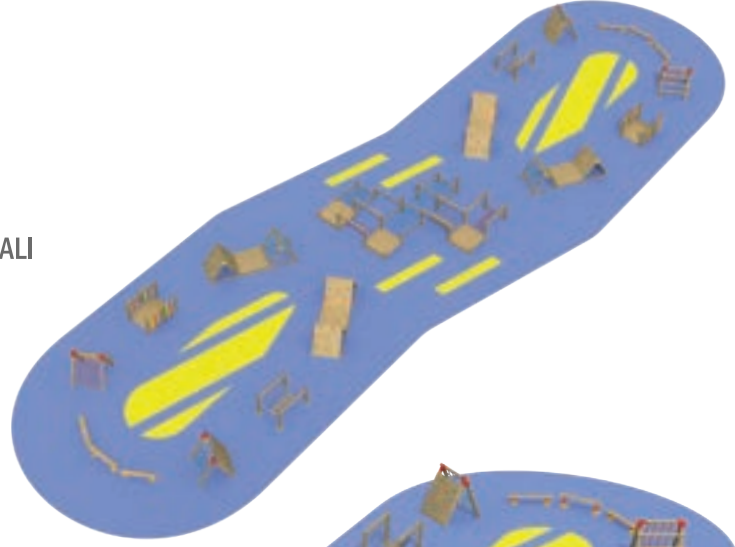

78

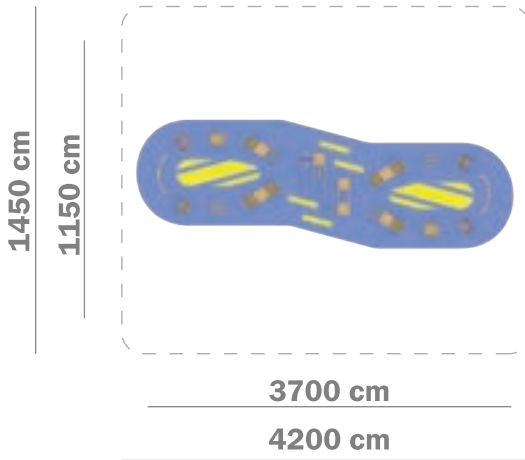

170  
Kişi

Kapasite

5  
yaş +

Yaş Grubu

Ürün Kodu  
AOP - 03







# AHSAP DÜNYASI

KENT MOBİLYALARI

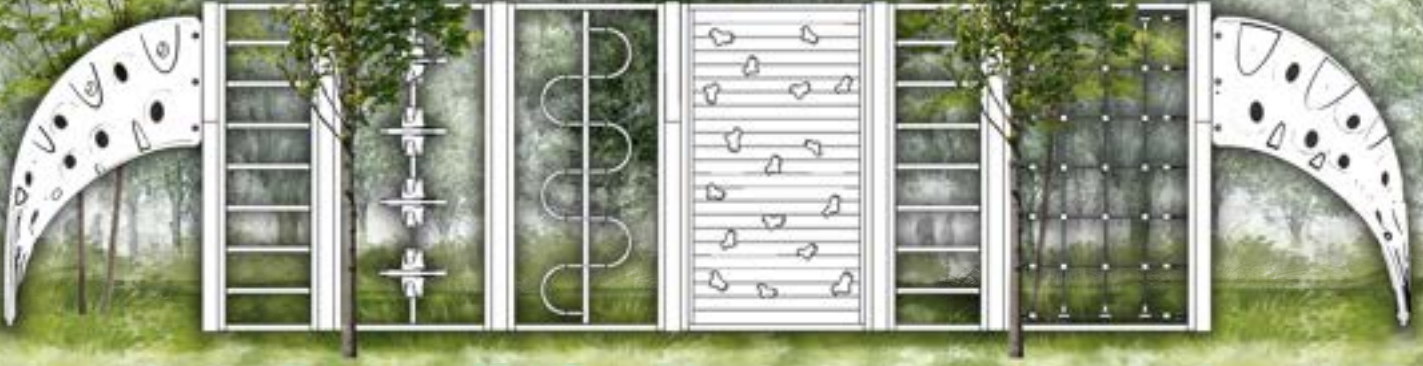

*Ahsap Oyun  
Parkuru  
Ekipmanları*

# AHŞAP OYUN PARKURU EKİPMANLARI

## TEKNİK ÖZELLİKLER

- 1. SINIF SARIÇAM
- VAKUMLU BASINÇLI EMPRENYE KORUMALI
- SUBAZLI AHŞAP BOYASI
- POLİETİLEN PLASTİK EKİPMANLAR

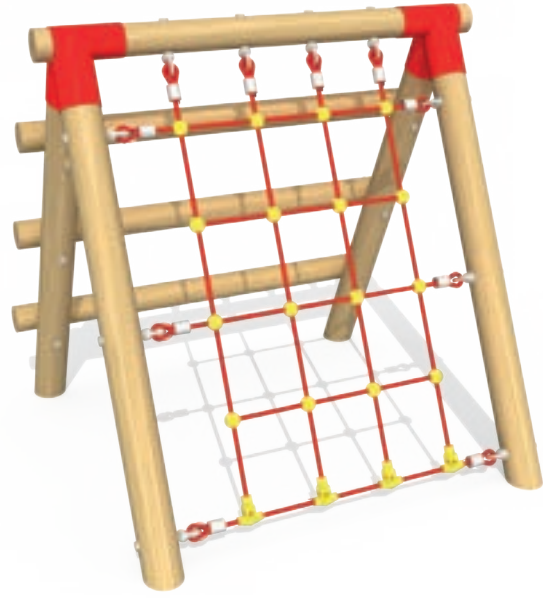
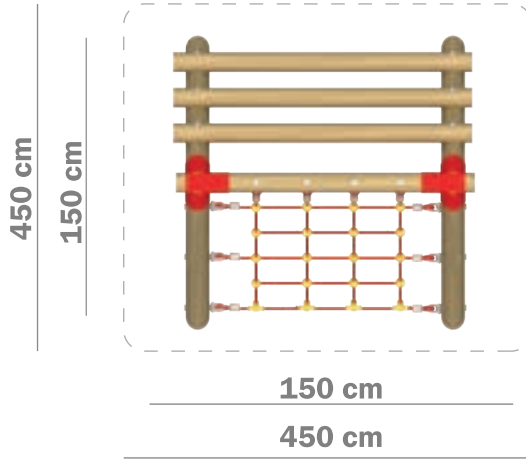

2  
Kişi

Kapasite

5  
yaş +

Yaş Grubu

Ürün Kodu  
APE - 01

80

## TEKNİK ÖZELLİKLER

- 1. SINIF SARIÇAM
- VAKUMLU BASINÇLI EMPRENYE KORUMALI
- SUBAZLI AHŞAP BOYASI
- POLİETİLEN PLASTİK EKİPMANLAR
- SICAK DALDIRMA GALVANİZ ZİNCİR

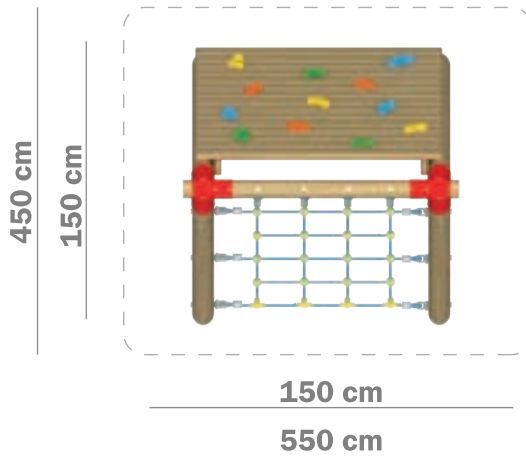

2  
Kişi

Kapasite

5  
yaş +

Yaş Grubu

Ürün Kodu  
APE - 02



# AHŞAP OYUN PARKURU EKİPMANLARI



## TEKNİK ÖZELLİKLER

- 1. SINIF SARIÇAM
- VAKUMLU BASINÇLI EMPRENYE KORUMALI
- SUBAZLI AHŞAP BOYASI
- POLİETİLEN PLASTİK EKİPMANLAR

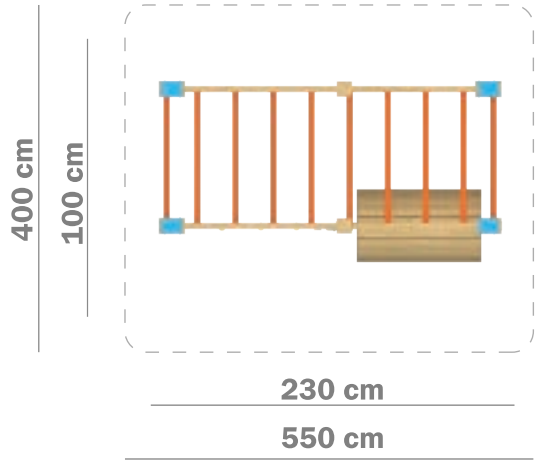

81

Ürün Kodu  
APE - 03

3

Kişi

Kapasite

5

yaş +

Yaş Grubu

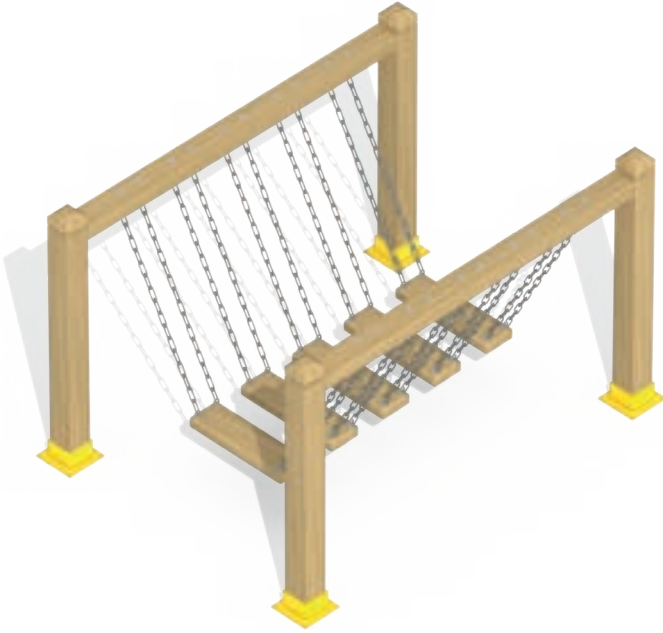

## TEKNİK ÖZELLİKLER

- 1. SINIF SARIÇAM
- VAKUMLU BASINÇLI EMPRENYE KORUMALI
- SUBAZLI AHŞAP BOYASI
- POLİETİLEN PLASTİK EKİPMANLAR

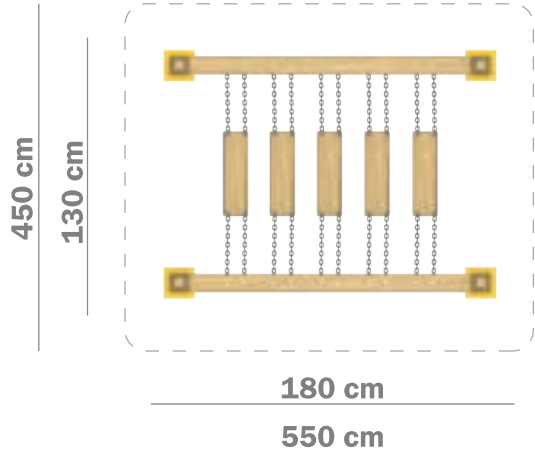

Ürün Kodu  
APE - 04

1

Kişi

Kapasite

5

yaş +

Yaş Grubu



**AHŞAP DÜNYASI**  
KENT MOBİLYALARI





## TEKNİK ÖZELLİKLER

- 1. SINIF SARIÇAM
- VAKUMLU BASINÇLI EMPRENYE KORUMALI
- SUBAZLI AHŞAP BOYASI
- POLİETİLEN PLASTİK EKİPMANLAR
- SICAK DALDIRMA GALVANİZ ZİNCİR

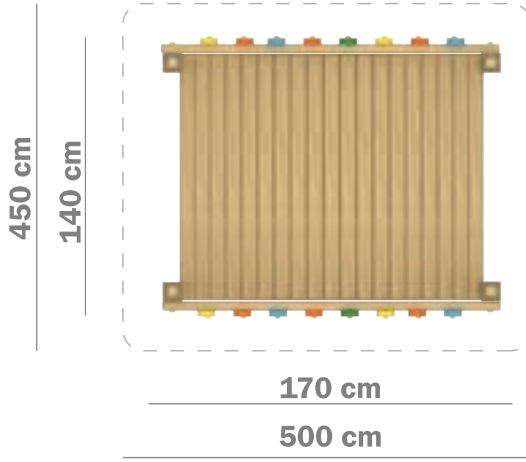

1  
Kişi

Kapasite

5  
yaş +

Yaş Grubu

Ürün Kodu  
APE - 05

82

## TEKNİK ÖZELLİKLER

- 1. SINIF SARIÇAM
- VAKUMLU BASINÇLI EMPRENYE KORUMALI
- SUBAZLI AHŞAP BOYASI
- POLİETİLEN PLASTİK EKİPMANLAR
- SICAK DALDIRMA GALVANİZ ZİNCİR

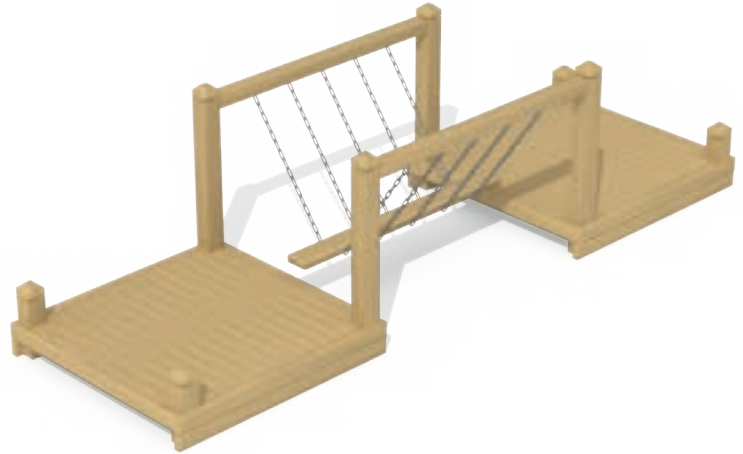
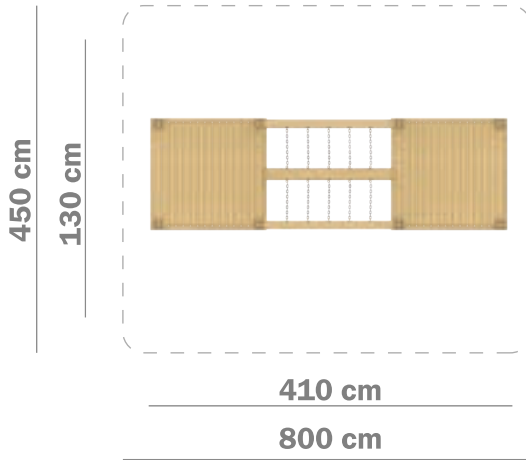

2  
Kişi

Kapasite

5  
yaş +

Yaş Grubu

Ürün Kodu  
APE - 06



# AHŞAP OYUN PARKURU EKİPMANLARI

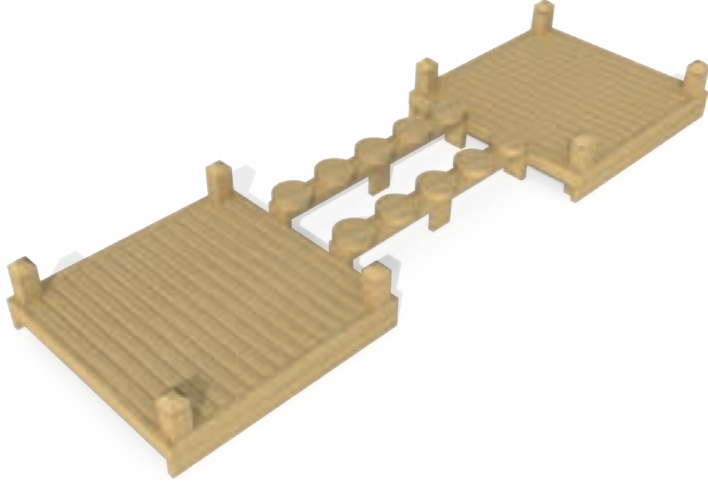

## TEKNİK ÖZELLİKLER

- 1. SINIF SARIÇAM
- VAKUMLU BASINÇLI EMPRENYE KORUMALI
- SUBAZLI AHŞAP BOYASI
- POLİETİLEN PLASTİK EKİPMANLAR

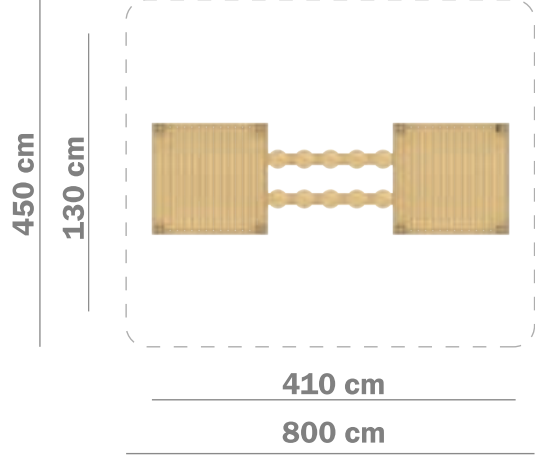

83

Ürün Kodu  
APE - 07

2

Kişi

Kapasite

5

yaş +

Yaş Grubu

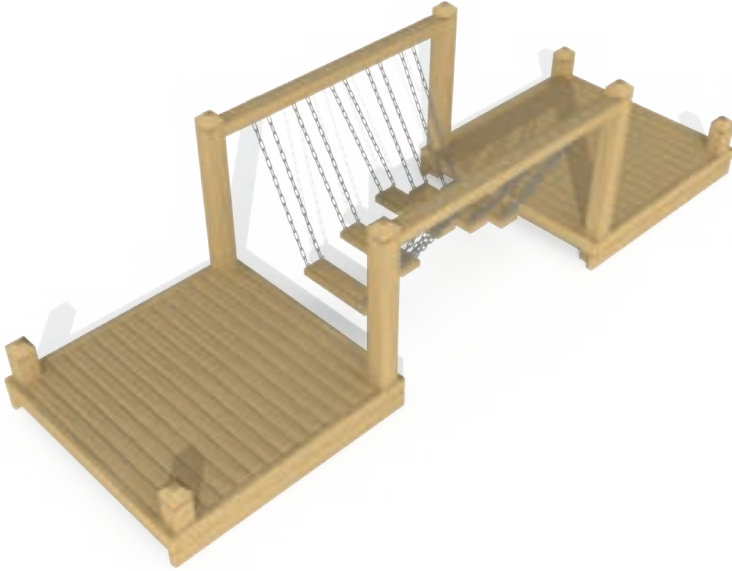

## TEKNİK ÖZELLİKLER

- 1. SINIF SARIÇAM
- VAKUMLU BASINÇLI EMPRENYE KORUMALI
- SUBAZLI AHŞAP BOYASI
- POLİETİLEN PLASTİK EKİPMANLAR
- SICAK DALDIRMA GALVANİZ ZİNCİR

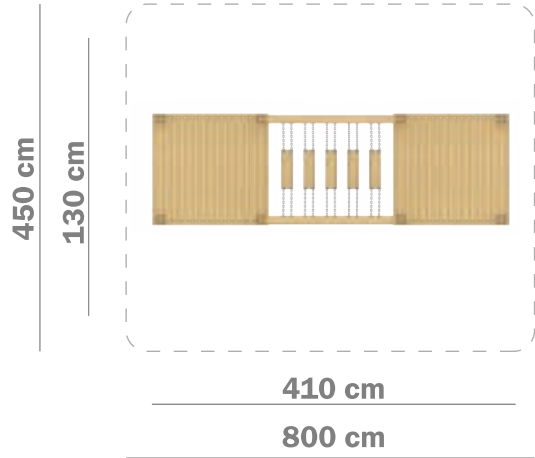

Ürün Kodu  
APE - 08

2

Kişi

Kapasite

5

yaş +

Yaş Grubu



**AHŞAP DÜNYASI**  
KENT MOBİLYALARI



[www.ahsapdunyasi.com.tr](http://www.ahsapdunyasi.com.tr)

[info@ahsapdunyasi.com.tr](mailto:info@ahsapdunyasi.com.tr)

# AHŞAP OYUN PARKURU EKİPMANLARI

## TEKNİK ÖZELLİKLER

- 1. SINIF SARIÇAM
- VAKUMLU BASINÇLI EMPRENYE KORUMALI
- SUBAZLI AHŞAP BOYASI
- POLİETİLEN PLASTİK EKİPMANLAR

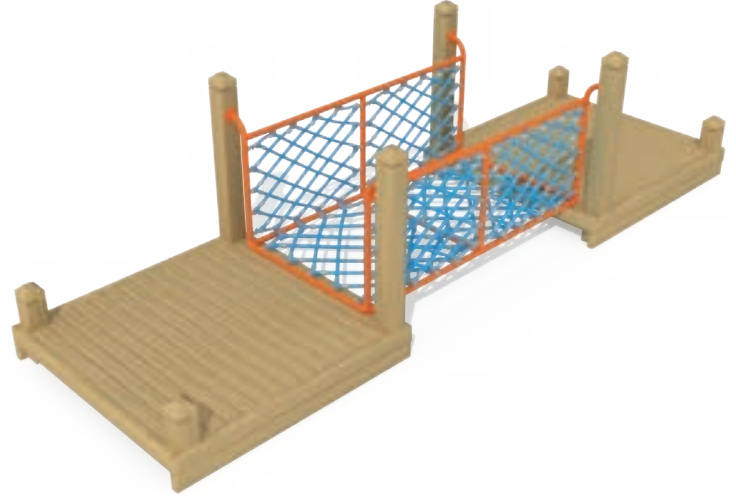
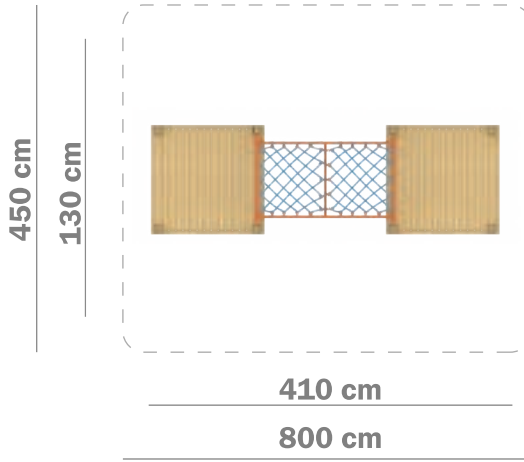

1  
Kişi  
Kapasite

5  
yaş +  
Yaş Grubu

Ürün Kodu  
APE - 09

84

## TEKNİK ÖZELLİKLER

- 1. SINIF SARIÇAM
- VAKUMLU BASINÇLI EMPRENYE KORUMALI
- SUBAZLI AHŞAP BOYASI
- POLİETİLEN PLASTİK EKİPMANLAR

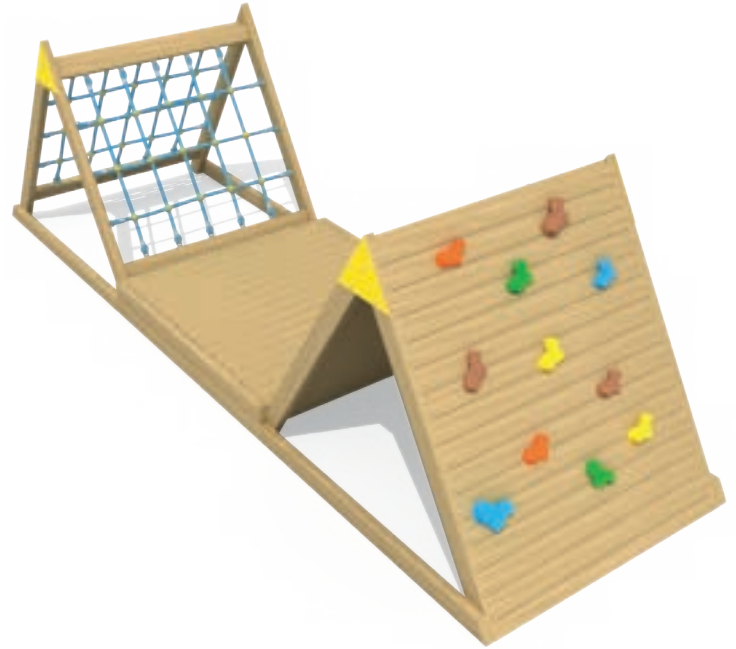
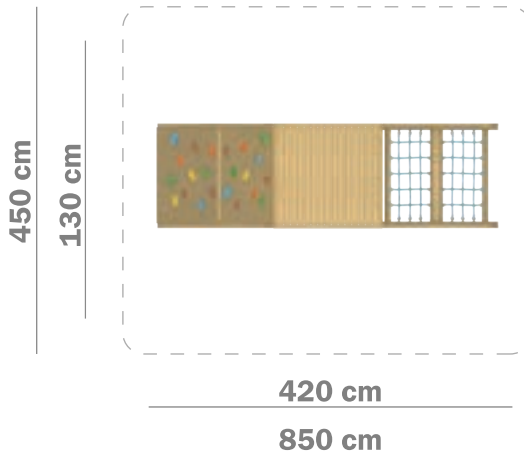

3  
Kişi  
Kapasite

5  
yaş +  
Yaş Grubu

Ürün Kodu  
APE - 10





# AHŞAP OYUN PARKURU EKİPMANLARI

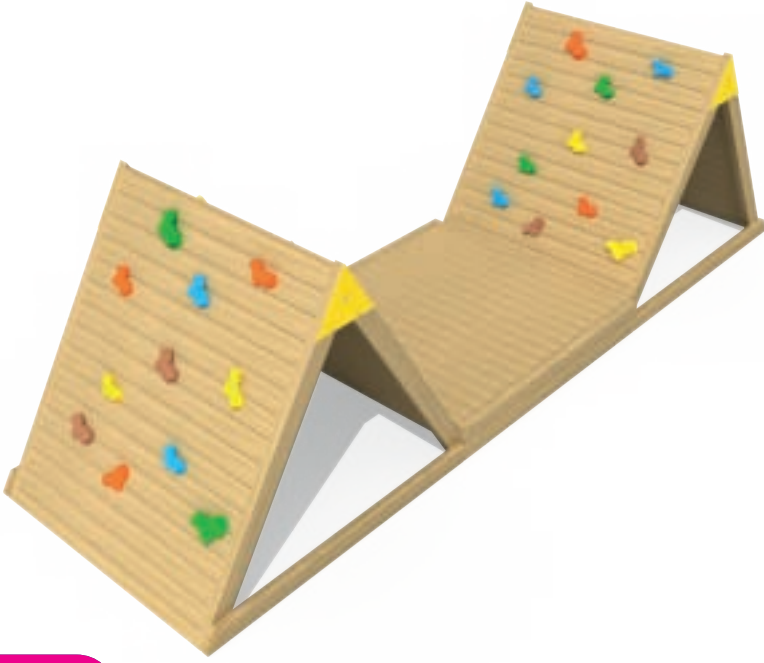

85

Ürün Kodu  
APE - 11

3

Kişi

Kapasite

5

yaş +

Yaş Grubu

## TEKNİK ÖZELLİKLER

- 1. SINIF SARIÇAM
- VAKUMLU BASINÇLI EMPRENYE KORUMALI
- SUBAZLI AHŞAP BOYASI
- POLİETİLEN PLASTİK EKİPMANLAR

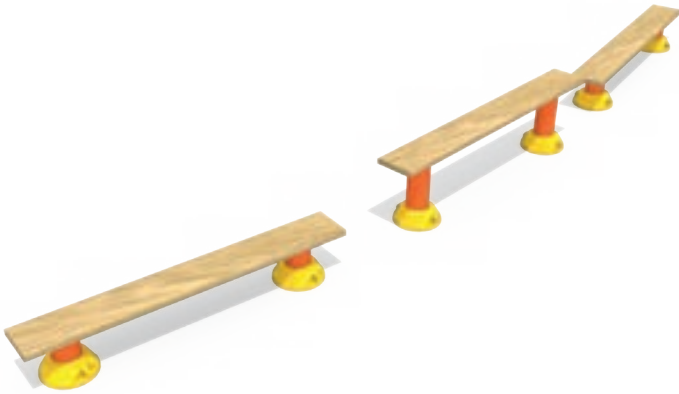
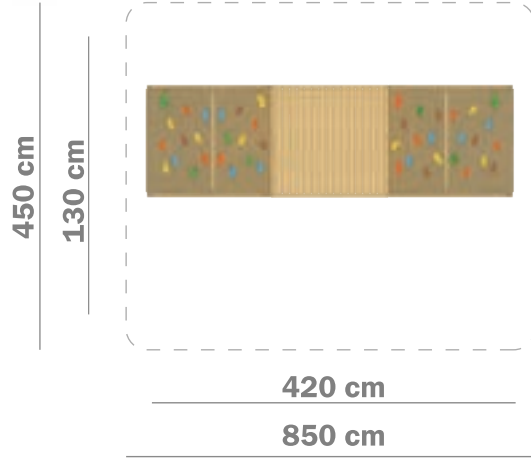

Ürün Kodu  
APE - 12

2

Kişi

Kapasite

5

yaş +

Yaş Grubu

## TEKNİK ÖZELLİKLER

- 1. SINIF SARIÇAM
- VAKUMLU BASINÇLI EMPRENYE KORUMALI
- SUBAZLI AHŞAP BOYASI
- POLİETİLEN PLASTİK EKİPMANLAR

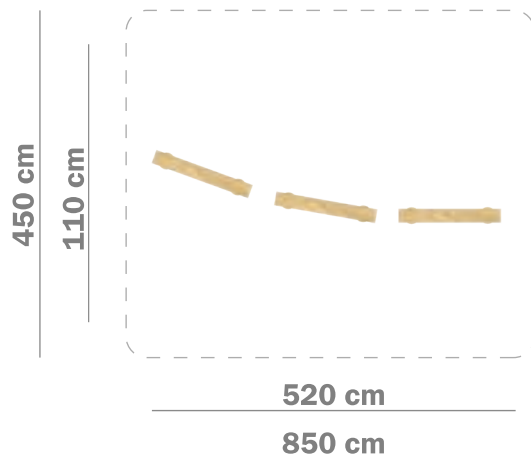

**AHŞAP DÜNYASI**  
KENT MOBİLYALARI



# AHŞAP OYUN PARKURU EKİPMANLARI

## TEKNİK ÖZELLİKLER

- 1. SINIF SARIÇAM
- VAKUMLU BASINÇLI EMPRENYE KORUMALI
- SUBAZLI AHŞAP BOYASI
- POLİETİLEN PLASTİK EKİPMANLAR

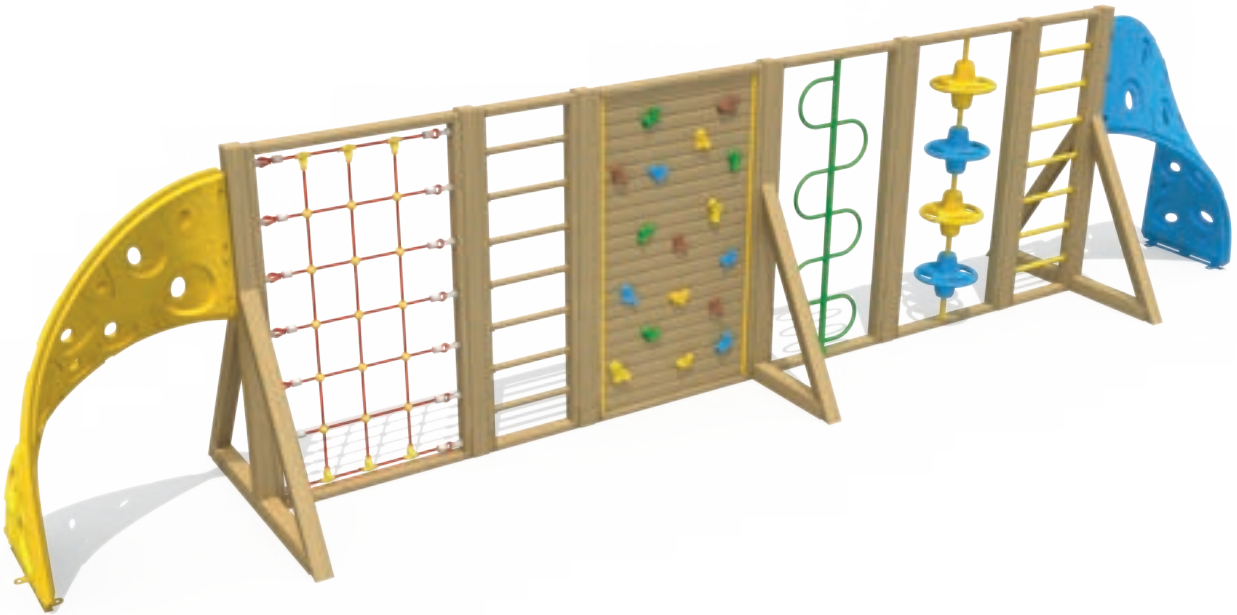
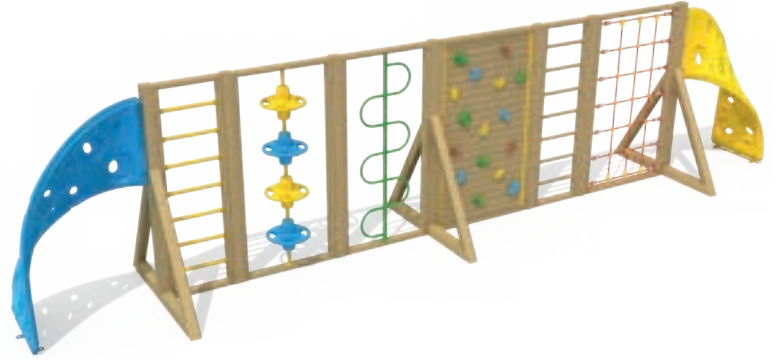

86

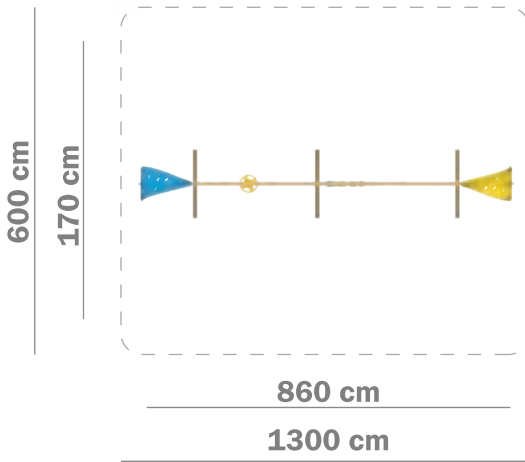

6  
Kişi  
Kapasite

5  
yaş +  
Yaş Grubu

Ürün Kodu  
APE - 13



# AHŞAP OYUN PARKURU EKİPMANLARI

## TEKNİK ÖZELLİKLER

- 1. SINIF SARIÇAM
- VAKUMLU BASINÇLI EMPRENYE KORUMALI
- SUBAZLI AHŞAP BOYASI
- POLİETİLEN PLASTİK EKİPMANLAR



87



Ürün Kodu  
**APE - 14**

**35**  
Kişi  
Kapasite

**5**  
yaş +  
Yaş Grubu

650 cm

330 cm

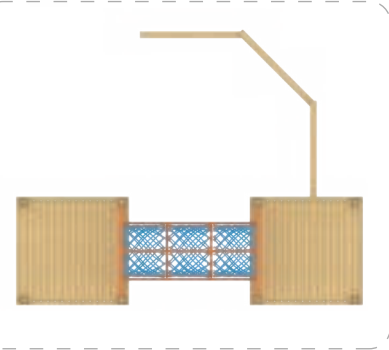

410 cm

750 cm



**AHŞAP DÜNYASI**  
KENT MOBİLYALARI



[www.ahsapdunyasi.com.tr](http://www.ahsapdunyasi.com.tr)

[info@ahsapdunyasi.com.tr](mailto:info@ahsapdunyasi.com.tr)



# AHŞAP OYUN PARKURU EKİPMANLARI

## TEKNİK ÖZELLİKLER

- 1. SINIF SARIÇAM
- VAKUMLU BASINÇLI EMPRENYE KORUMALI
- SUBAZLI AHŞAP BOYASI
- POLİETİLEN PLASTİK EKİPMANLAR
- SICAK DALDIRMA GALVANİZ ZİNCİR

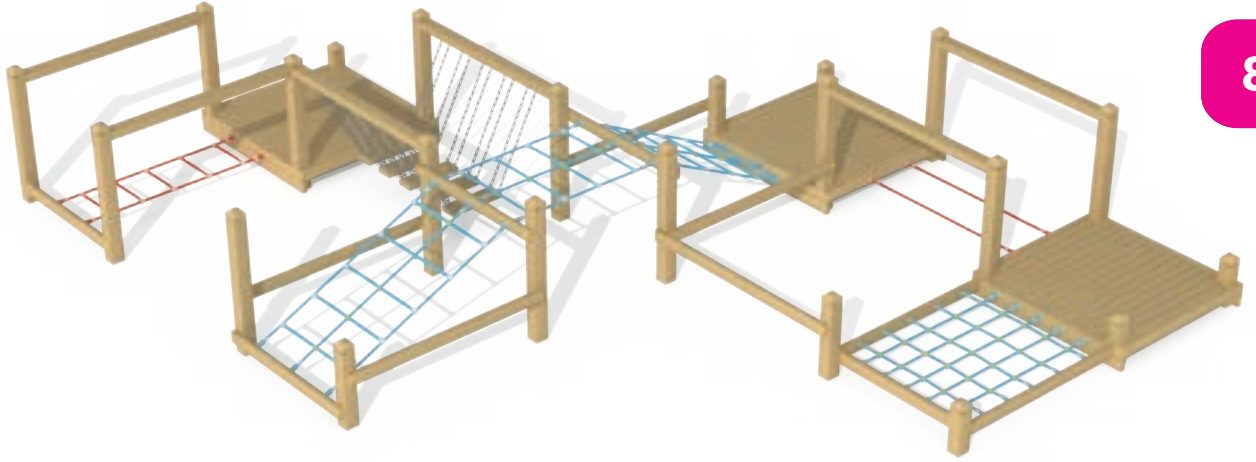
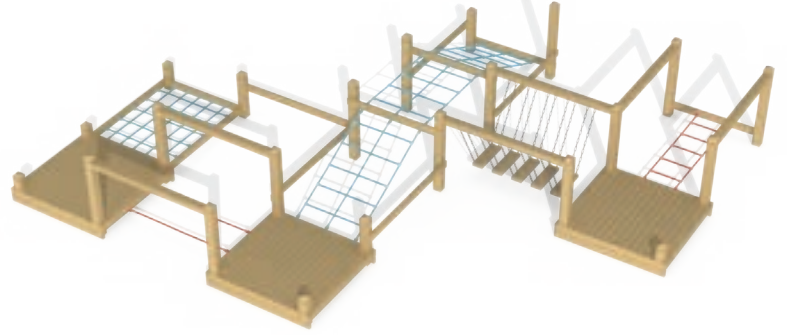

88

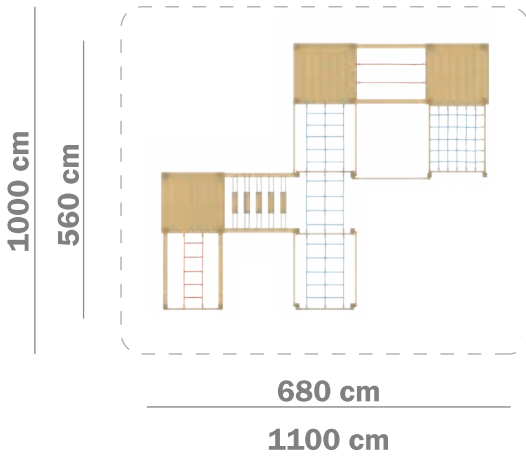

15

Kişi

Kapasite

5

yaş +

Yaş Grubu

Ürün Kodu  
APE - 15





# AHŞAP DÜNYASI

KENT MOBİLYALARI



*Metal Oyun  
Parkurları*

## TEKNİK ÖZELLİKLER

- SICAK DALDIRMA GALVANİZ TAŞIYICI
- METAL AKSAMLAR ELEKTROSTATİK TOZ BOYALI
- POLİETİLEN PLASTİK EKİPMANLAR
- SICAK DALDIRMA GALVANİZ ZİNCİR

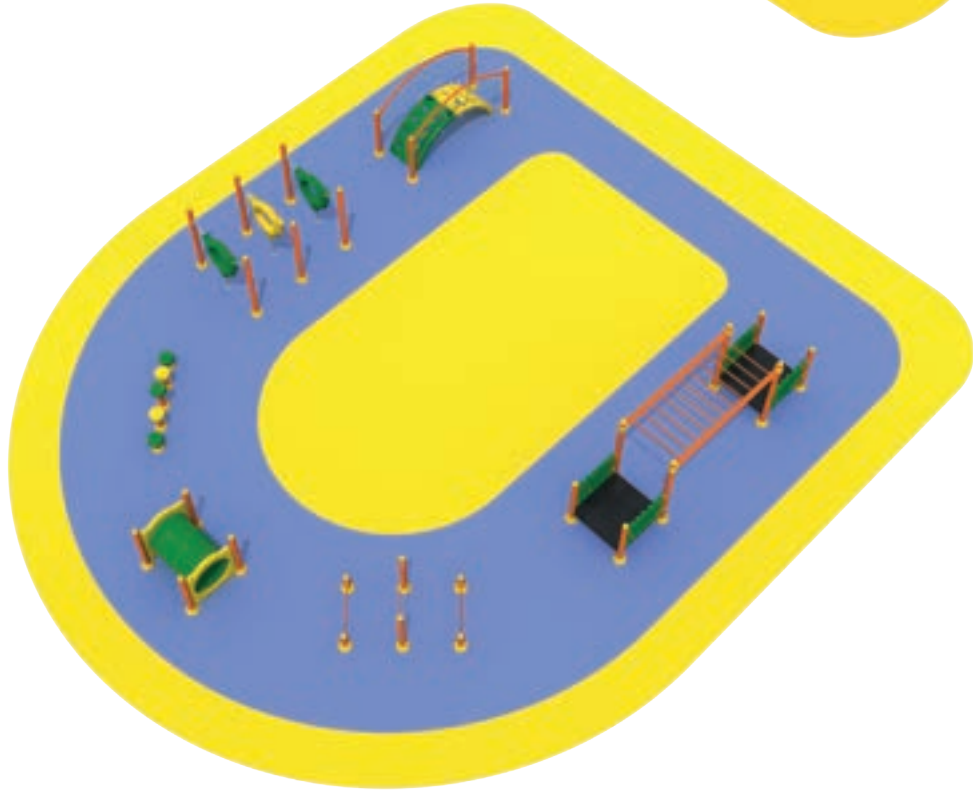

90

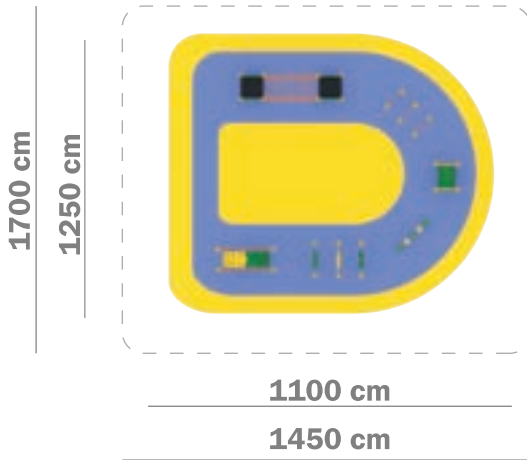

55

Kişi

Kapasite

5

yaş +

Yaş Grubu

Ürün Kodu  
MOP-01





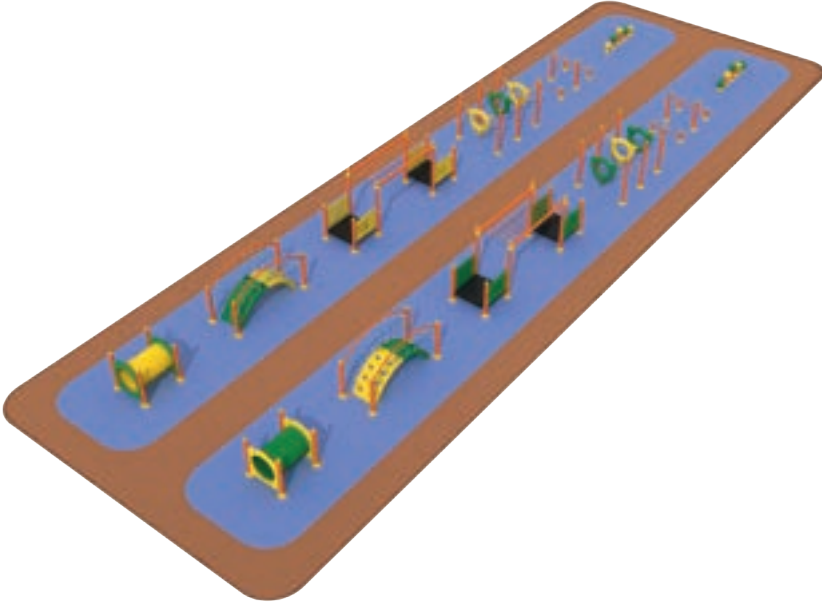

## TEKNİK ÖZELLİKLER

- SICAK DALDIRMA GALVANİZ TAŞIYICI
- METAL AKSAMLAR ELEKTROSTATİK TOZ BOYALI
- POLİETİLEN PLASTİK EKİPMANLAR
- SICAK DALDIRMA GALVANİZ ZİNCİR

91

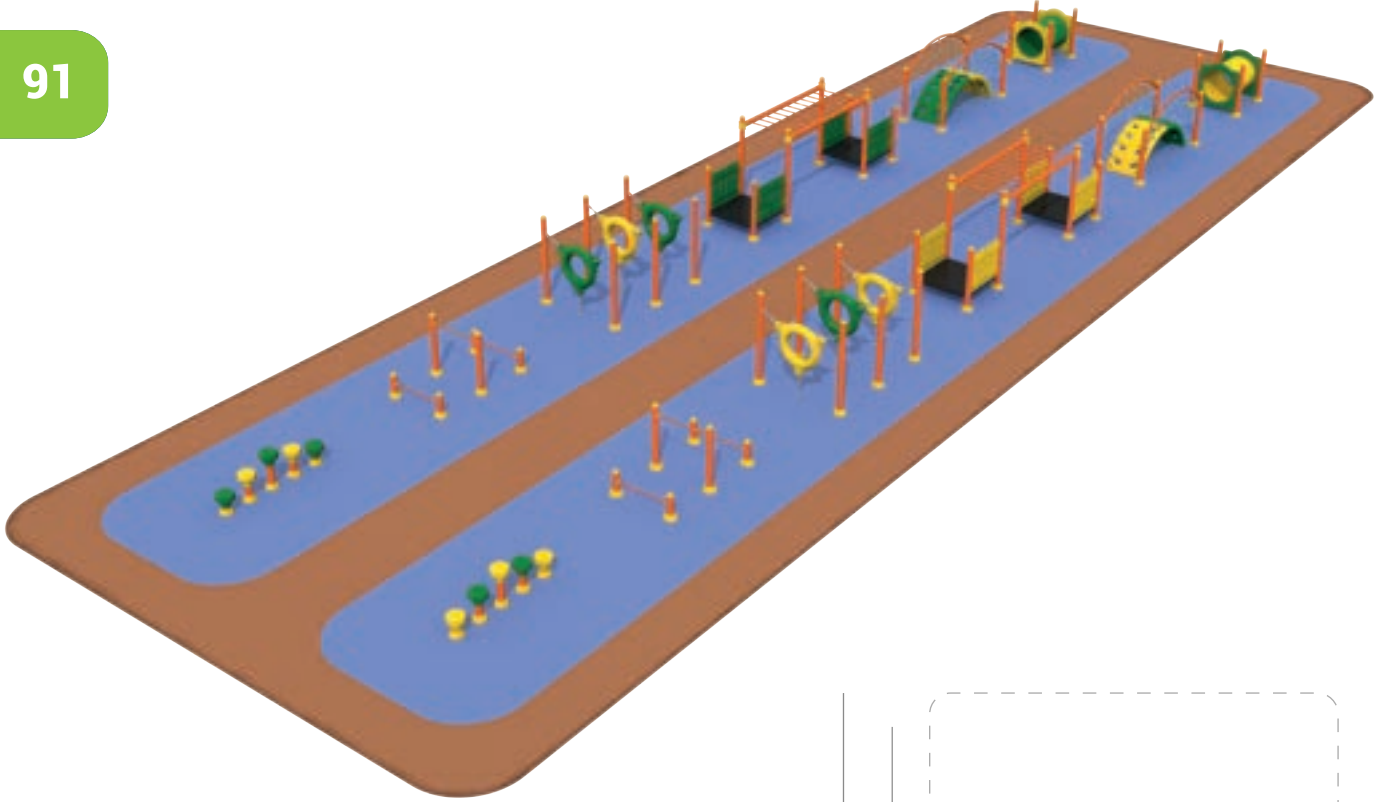

Ürün Kodu  
**MOP - 02**

**75**  
Kişi

Kapasite

**5**  
yaş +

Yaş Grubu

1050 cm

700 cm

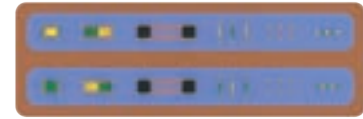

2700 cm

3200 cm



**AHSAP DÜNYASI**  
KENT MOBİLYALARI

## TEKNİK ÖZELLİKLER

- SICAK DALDIRMA GALVANİZ TAŞIYICI
- METAL AKSAMLAR ELEKTROSTATİK TOZ BOYALI
- POLİETİLEN PLASTİK EKİPMANLAR
- SICAK DALDIRMA GALVANİZ ZİNCİR



92

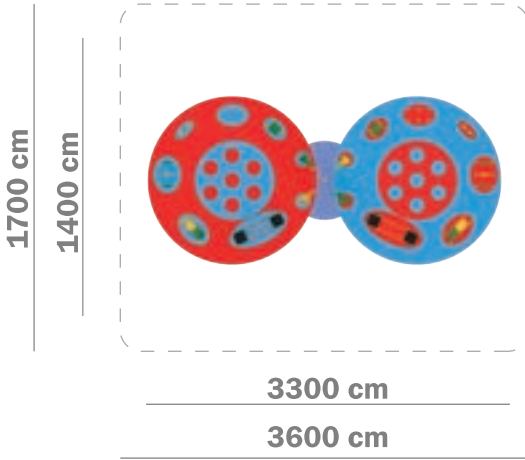

184

Kişi

Kapasite

5

yaş +

Yaş Grubu

Ürün Kodu  
MOP - 03







# AHSAP DÜNYASI

KENT MOBİLYALARI



*Metal Oyun  
Parkuru  
Ekipmanları*



# METAL OYUN PARKURU EKİPMANLARI

## TEKNİK ÖZELLİKLER

- SICAK DALDIRMA GALVANİZ TAŞIYICI
- METAL AKSAMLAR ELEKTROSTATİK TOZ BOYALI
- POLİETİLEN PLASTİK EKİPMANLAR

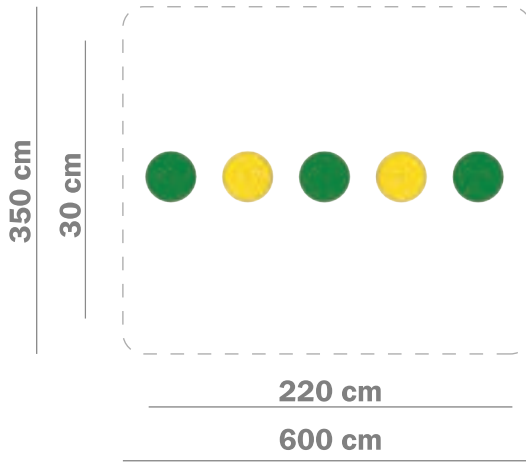

1  
Kişi  
Kapasite

5  
yaş +  
Yaş Grubu

İrün Kodu  
MPE - 01

94

## TEKNİK ÖZELLİKLER

- SICAK DALDIRMA GALVANİZ TAŞIYICI
- METAL AKSAMLAR ELEKTROSTATİK TOZ BOYALI
- POLİETİLEN PLASTİK EKİPMANLAR

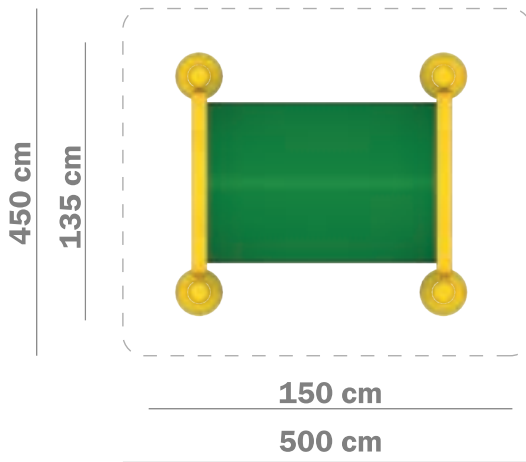

2  
Kişi  
Kapasite

5  
yaş +  
Yaş Grubu

İrün Kodu  
MPE - 02



# METAL OYUN PARKURU EKİPMANLARI

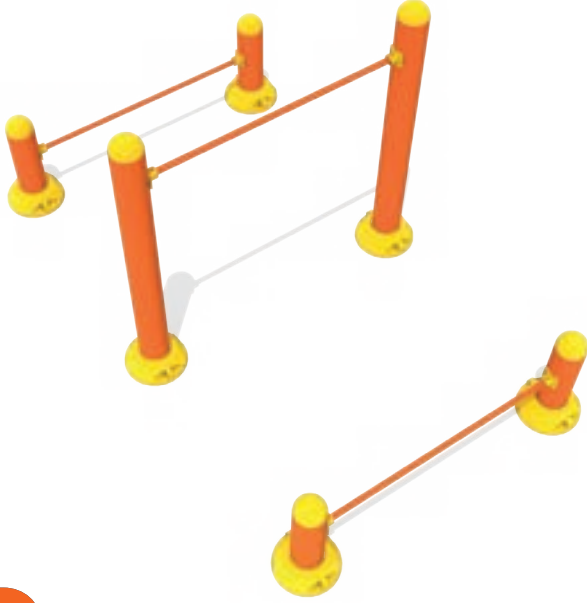

95

Ürün Kodu  
MPE - 03

2  
Kişi  
Kapasite

5  
yaş +  
Yaş Grubu

## TEKNİK ÖZELLİKLER

- SICAK DALDIRMA GALVANİZ TAŞIYICI
- METAL AKSAMLAR ELEKTROSTATİK TOZ BOYALI
- POLİETİLEN PLASTİK EKİPMANLAR

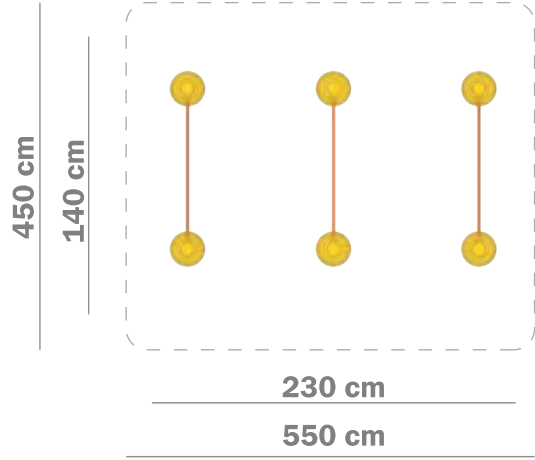

Ürün Kodu  
MPE - 04

2  
Kişi  
Kapasite

5  
yaş +  
Yaş Grubu

## TEKNİK ÖZELLİKLER

- SICAK DALDIRMA GALVANİZ TAŞIYICI
- METAL AKSAMLAR ELEKTROSTATİK TOZ BOYALI
- POLİETİLEN PLASTİK EKİPMANLAR

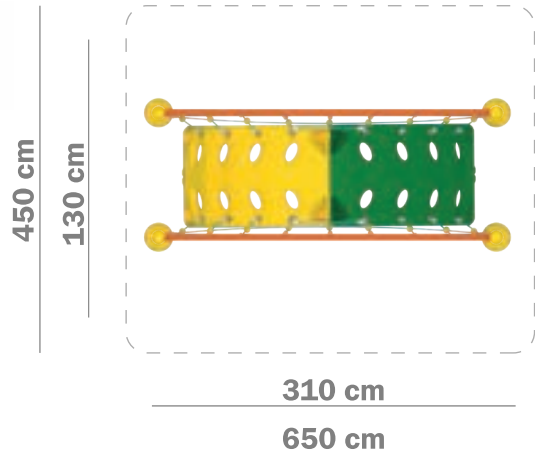

**AHSAP DÜNYASI**  
KENT MOBİLYALARI



[www.ahsapdunyasi.com.tr](http://www.ahsapdunyasi.com.tr)

[info@ahsapdunyasi.com.tr](mailto:info@ahsapdunyasi.com.tr)

# METAL OYUN PARKURU EKİPMANLARI

## TEKNİK ÖZELLİKLER

- SICAK DALDIRMA GALVANİZ TAŞIYICI
- METAL AKSAMLAR ELEKTROSTATİK TOZ BOYALI
- POLİETİLEN PLASTİK EKİPMANLAR

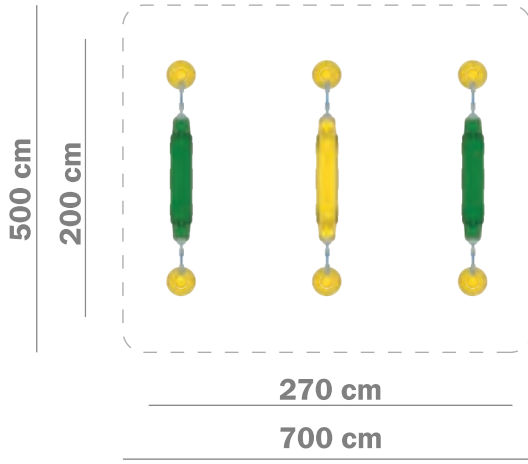

2  
Kişi  
Kapasite

5  
yaş +  
Yaş Grubu

Ürün Kodu  
MPE - 05

96

## TEKNİK ÖZELLİKLER

- SICAK DALDIRMA GALVANİZ TAŞIYICI
- METAL AKSAMLAR ELEKTROSTATİK TOZ BOYALI
- POLİETİLEN PLASTİK EKİPMANLAR

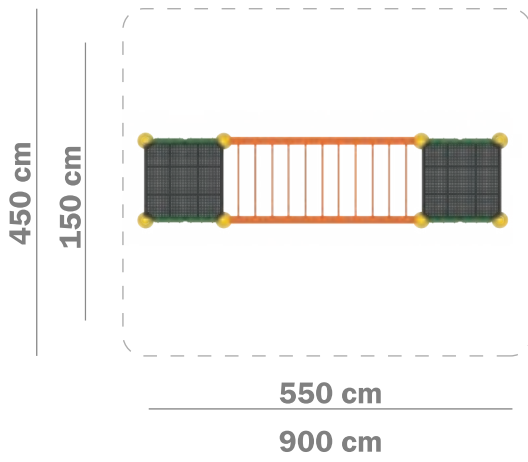

3  
Kişi  
Kapasite

5  
yaş +  
Yaş Grubu

Ürün Kodu  
MPE - 06







# AHSAP DÜNYASI

KENT MOBİLYALARI



*Ekipmanlar*

## TEKNİK ÖZELLİKLER

- SICAK DALDIRMA GALVANİZ TAŞIYICI
- METAL AKSAMLAR ELEKTROSTATİK TOZ BOYALI
- POLİETİLEN PLASTİK EKİPMANLAR
- SICAK DALDIRMA GALVANİZ ZİNCİR

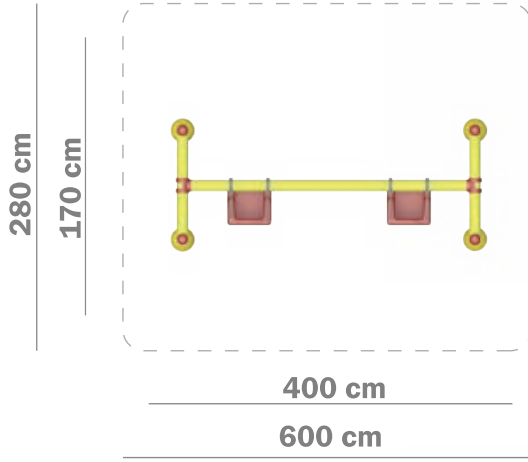

2  
Kişi

Kapasite

3  
yaş +

Yaş Grubu

Ürün Kodu  
**E - 01**  
İkili Sabneak

98

## TEKNİK ÖZELLİKLER

- SICAK DALDIRMA GALVANİZ TAŞIYICI
- METAL AKSAMLAR ELEKTROSTATİK TOZ BOYALI
- POLİETİLEN PLASTİK EKİPMANLAR
- SICAK DALDIRMA GALVANİZ ZİNCİR

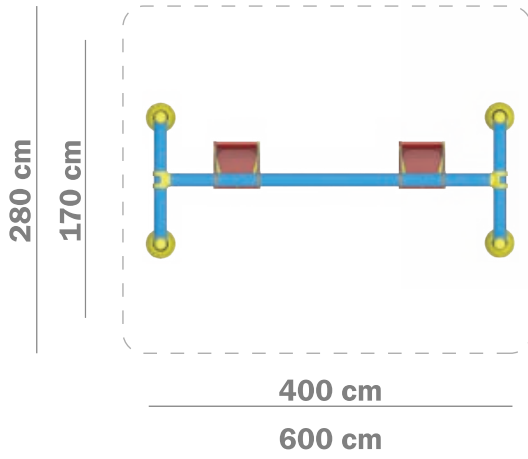

2  
Kişi

Kapasite

3  
yaş +

Yaş Grubu

Ürün Kodu  
**E - 02**  
Engelsiz Sabneak





2

Kişi

Kapasite

3

yaş +

Yaş Grubu

Ürün Kodu

E - 03

Kuş Kafesi Salıncak

## TEKNİK ÖZELLİKLER

- SICAK DALDIRMA GALVANİZ TAŞIYICI
- METAL AKSAMLAR ELEKTROSTATİK TOZ BOYALI
- POLİETİLEN PLASTİK EKİPMANLAR
- SICAK DALDIRMA GALVANİZ ZİNCİR

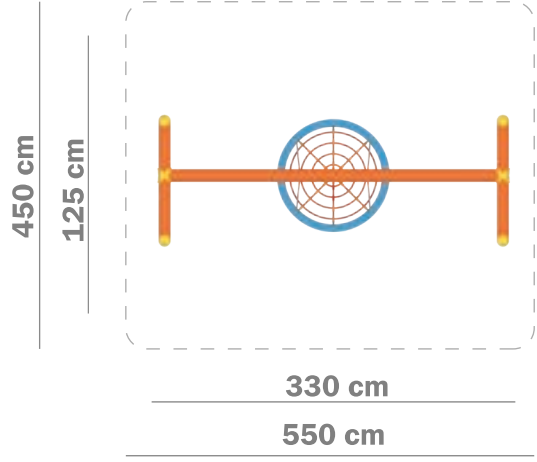

99



2

Kişi

Kapasite

3

yaş +

Yaş Grubu

Ürün Kodu

E - 04

Ebeveyn Salıncak

## TEKNİK ÖZELLİKLER

- SICAK DALDIRMA GALVANİZ TAŞIYICI
- METAL AKSAMLAR ELEKTROSTATİK TOZ BOYALI
- POLİETİLEN PLASTİK EKİPMANLAR
- SICAK DALDIRMA GALVANİZ ZİNCİR

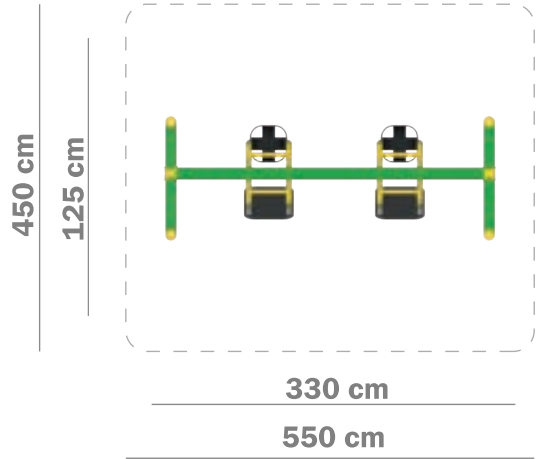



## TEKNİK ÖZELLİKLER

- 1. SINIF SARIÇAM
- VAKUMLU BASINÇLI EMPRENYE KORUMALI
- SUBAZLI AHŞAP BOYASI
- POLİETİLEN PLASTİK EKİPMANLAR
- SICAK DALDIRMA GALVANİZ ZİNCİR

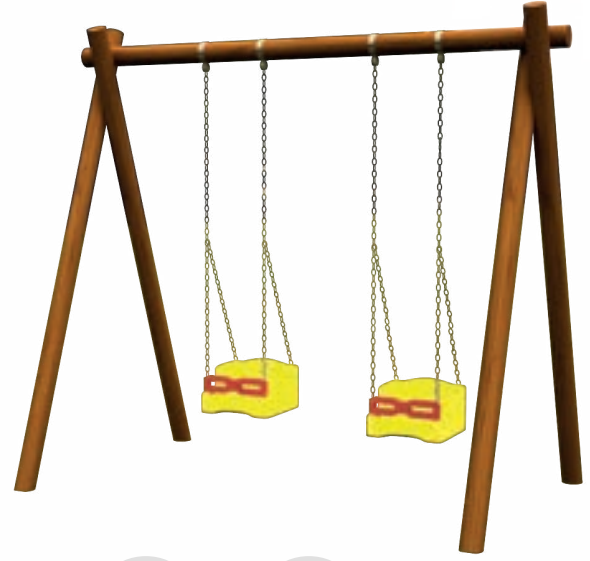
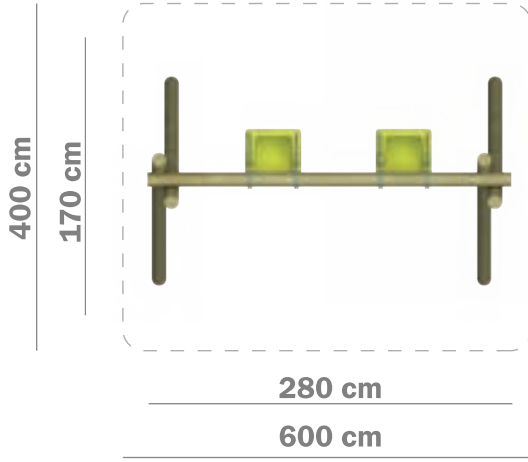

2  
Kişi

Kapasite

3  
yaş +

Yaş Grubu

Ürün Kodu  
**E - 05**  
Ahşap İkili Salınak

100

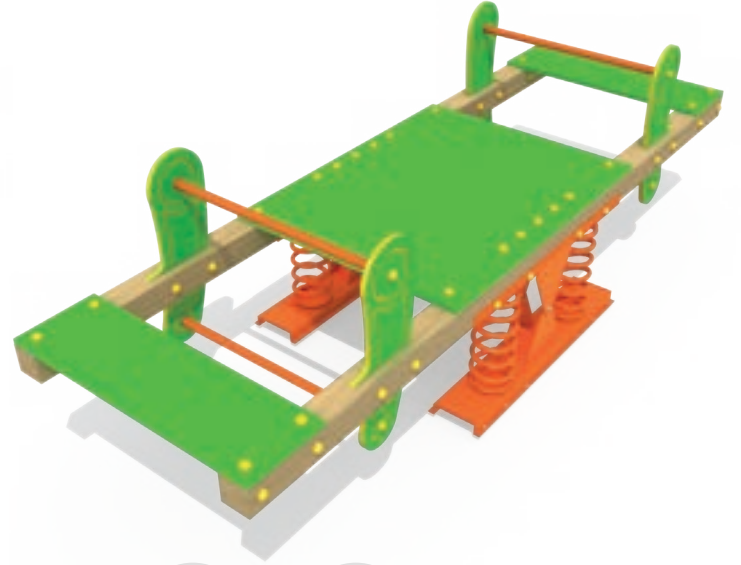
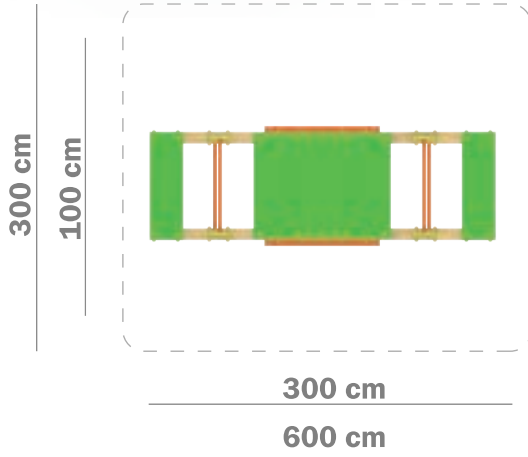
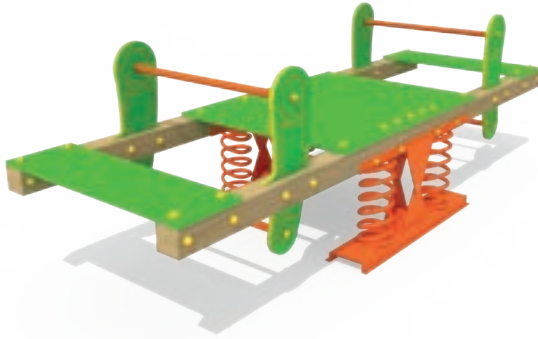

2  
Kişi

Kapasite

3  
yaş +

Yaş Grubu

Ürün Kodu  
**E - 06**  
Figürlü Tahterevalli



# ERİPMANLAR

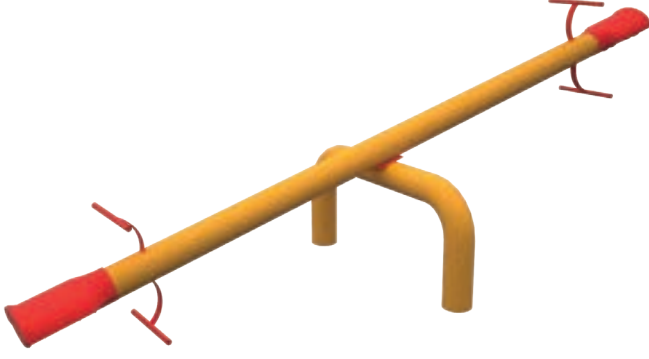

200 cm

70 cm

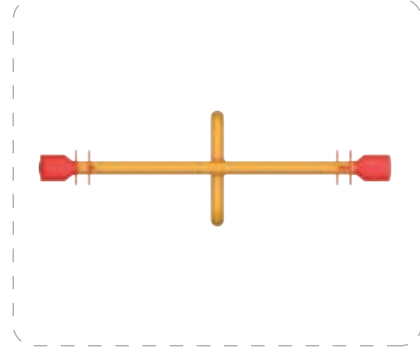

300 cm

500 cm

2  
Kişi

Kapasite

3  
yaş +

Yaş Grubu

Ürün Kodu  
**E - 07**  
İkili Tahterevalli

101

300 cm

150 cm

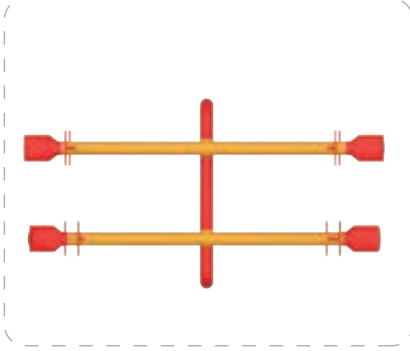

300 cm

500 cm

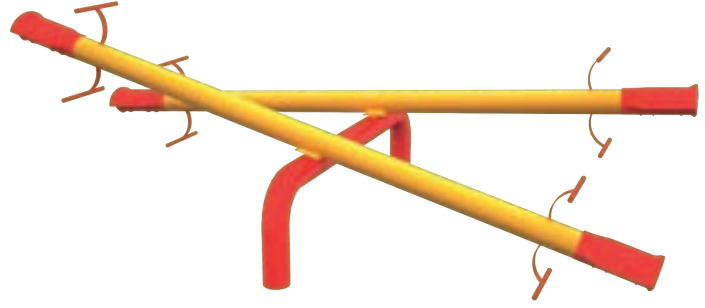

4  
Kişi

Kapasite

3  
yaş +

Yaş Grubu

Ürün Kodu  
**E - 08**  
Dörtlü Tahterevalli

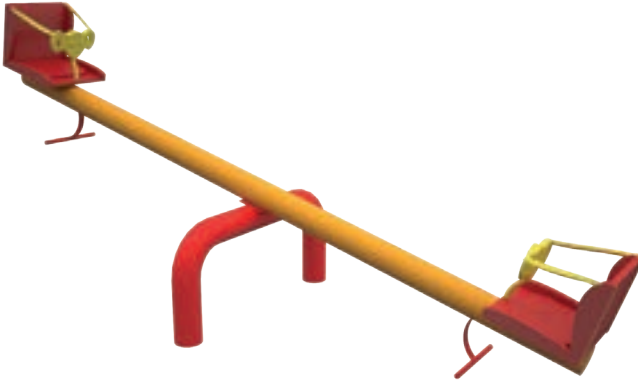

200 cm

70 cm

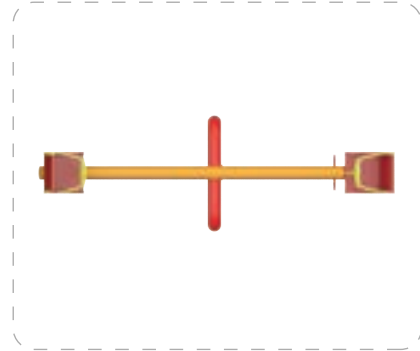

300 cm

500 cm

2  
Kişi

Kapasite

3  
yaş +

Yaş Grubu

Ürün Kodu  
**E - 09**  
Engelsiz Tahterevalli



**AHSAP DÜNYASI**  
KENT MOBİLYALARI

[www.ahsapdunyasi.com.tr](http://www.ahsapdunyasi.com.tr)

[info@ahsapdunyasi.com.tr](mailto:info@ahsapdunyasi.com.tr)



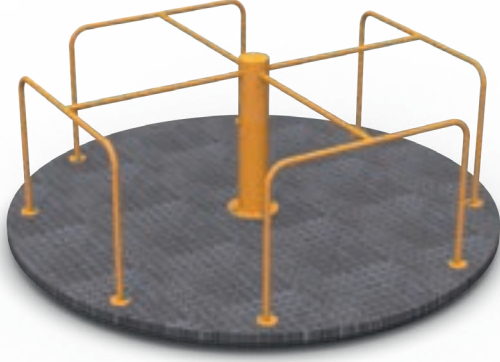

4  
Kişi

Kapasite

5  
yaş +

Yaş Grubu

Ürün Kodu  
**E - 10**  
Döner Platform

550 cm

250 cm

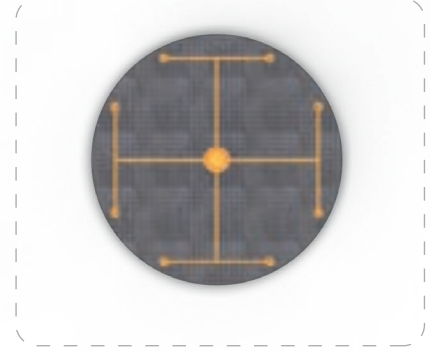

250 cm

550 cm

550 cm

230 cm

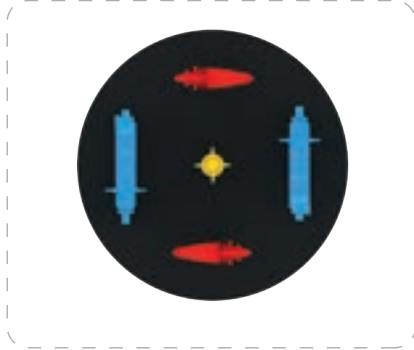

230 cm

550 cm



102

4  
Kişi

Kapasite

5  
yaş +

Yaş Grubu

Ürün Kodu  
**E - 11**  
Figürlü Döner Platform



4  
Kişi

Kapasite

5  
yaş +

Yaş Grubu

Ürün Kodu  
**E - 12**  
Halatlı Döner Platform

600 cm

250 cm

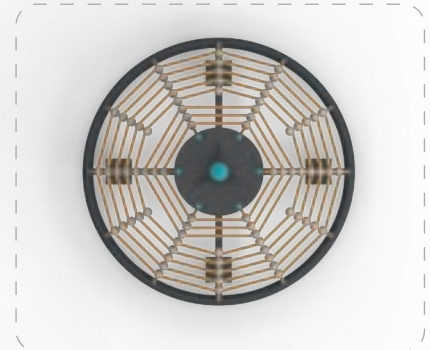

250 cm

600 cm







3

Kişi

Kapasite

5

yaş +

Yaş Grubu

Ürün Kodu

E - 13

Romando Halka

## TEKNİK ÖZELLİKLER

- SICAK DALDIRMA GALVANİZ TAŞIYICI
- METAL AKSAMLAR ELEKTROSTATİK TOZ BOYALI
- POLİETİLEN PLASTİK EKİPMANLAR

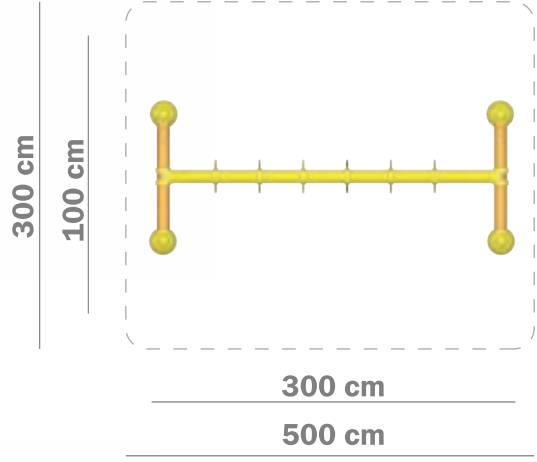

103



3

Kişi

Kapasite

5

yaş +

Yaş Grubu

Ürün Kodu

E - 14

Yatay Merdiven

## TEKNİK ÖZELLİKLER

- SICAK DALDIRMA GALVANİZ TAŞIYICI
- METAL AKSAMLAR ELEKTROSTATİK TOZ BOYALI
- POLİETİLEN PLASTİK EKİPMANLAR

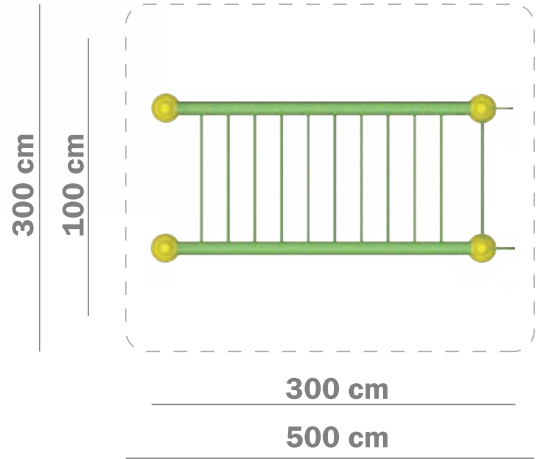

## TEKNİK ÖZELLİKLER

- SICAK DALDIRMA GALVANİZ TAŞIYICI
- METAL AKSAMLAR ELEKTROSTATİK TOZ BOYALI
- POLİETİLEN PLASTİK EKİPMANLAR

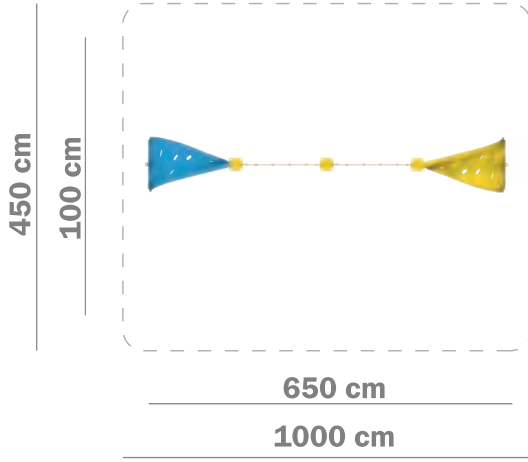

5

Kişi

Kapasite

3

yaş +

Yaş Grubu

Ürün Kodu  
**E - 15**  
İkili Burgu Tırmanma

104

## TEKNİK ÖZELLİKLER

- SICAK DALDIRMA GALVANİZ TAŞIYICI
- METAL AKSAMLAR ELEKTROSTATİK TOZ BOYALI
- POLİETİLEN PLASTİK EKİPMANLAR

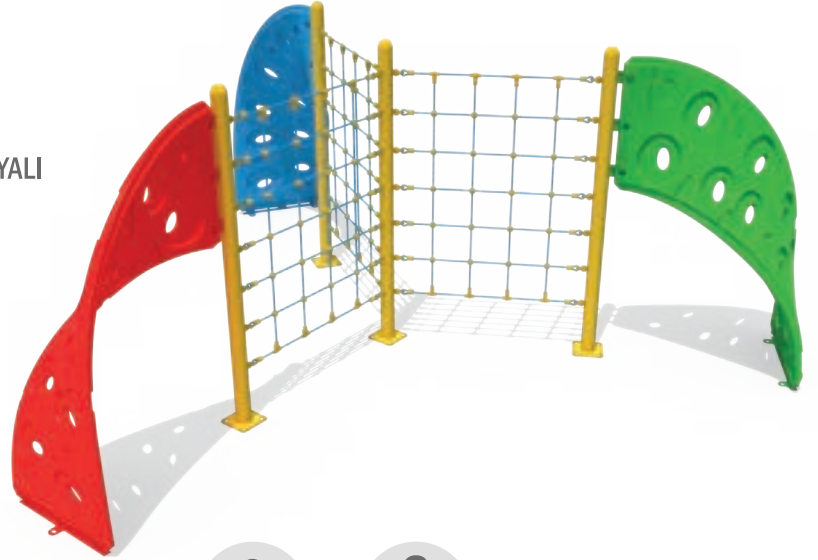
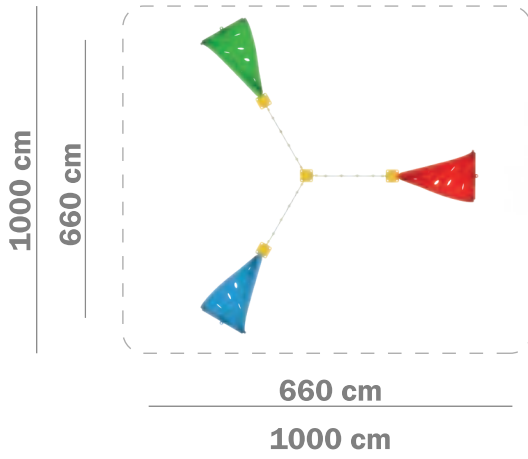

9

Kişi

Kapasite

3

yaş +

Yaş Grubu

Ürün Kodu  
**E - 16**  
Üçlü Burgu Tırmanma





3

Kişi

Kapasite

5

yaş +

Yaş Grubu

Ürün Kodu  
E - 17  
İkili Burgu

## TEKNİK ÖZELLİKLER

- SICAK DALDIRMA GALVANİZ TAŞIYICI
- METAL AKSAMLAR ELEKTROSTATİK TOZ BOYALI
- POLİETİLEN PLASTİK EKİPMANLAR

350 cm

50 cm

200 cm

600 cm

105

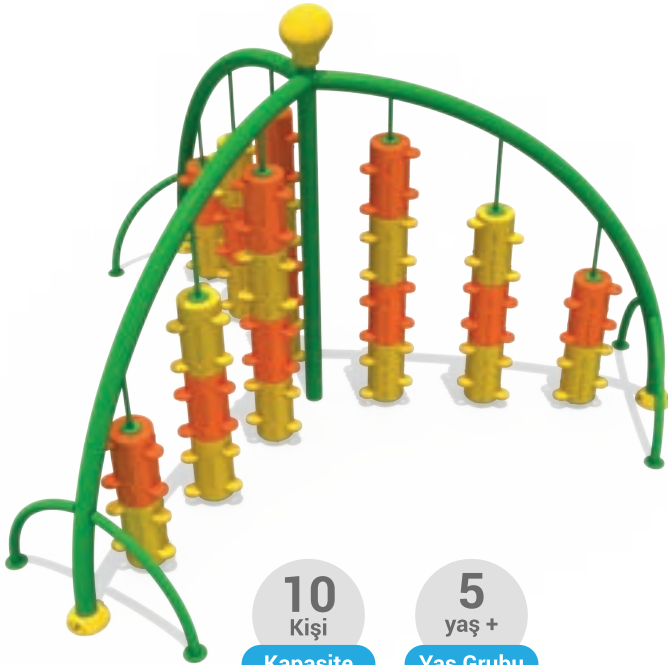

10

Kişi

Kapasite

5

yaş +

Yaş Grubu

Ürün Kodu  
E - 18  
Üçlü Burgu

## TEKNİK ÖZELLİKLER

- SICAK DALDIRMA GALVANİZ TAŞIYICI
- METAL AKSAMLAR ELEKTROSTATİK TOZ BOYALI
- POLİETİLEN PLASTİK EKİPMANLAR

800 cm

500 cm

500 cm

800 cm







Ürün Kodu  
E - 19  
Polietilen Zıp Zıp

Ürün Kodu  
E - 20  
Polietilen Zıp Zıp

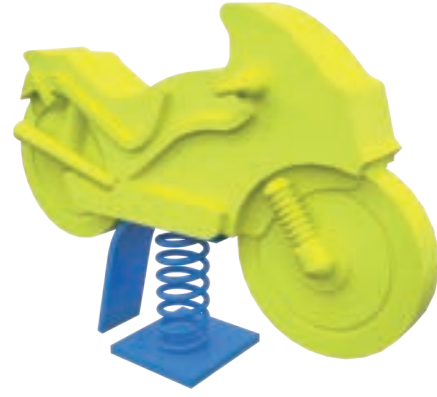

106



Ürün Kodu  
E - 21  
Polietilen Zıp Zıp

Ürün Kodu  
E - 22  
Polietilen Zıp Zıp



Ürün Kodu  
E - 23  
HDPE - Zıp Zıp



107



Ürün Kodu  
E - 24  
HDPE - Zıp Zıp

Ürün Kodu  
E - 25  
HDPE - Zıp Zıp



Ürün Kodu  
E - 26  
HDPE - Zıp Zıp





Ürün Kodu  
E - 27  
HDPE - Zıp Zıp

Ürün Kodu  
E - 28  
HDPE - Zıp Zıp



108

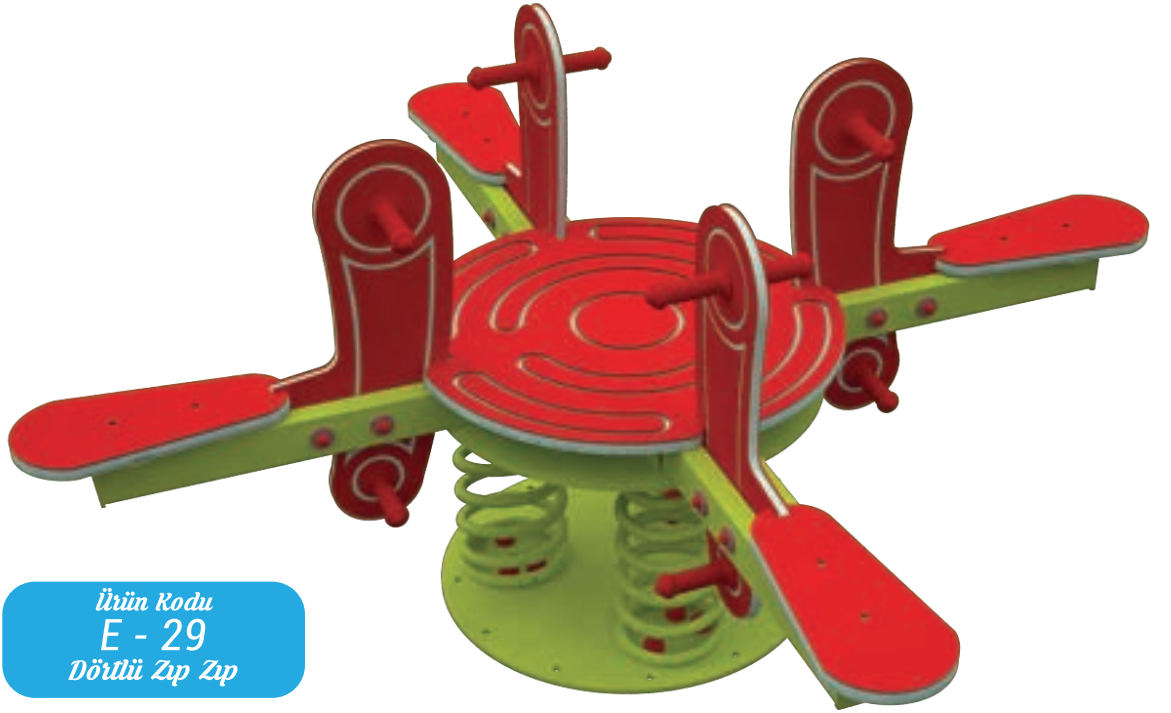

Ürün Kodu  
E - 29  
Dörtlü Zıp Zıp







# AHŞAP DÜNYASI

KENT MOBİLYALARI

*Kültür*  
*Fizik*

TEKNİK ÖZELLİKLER

- SICAK DALDIRMA GALVANİZ TAŞIYICI
- METAL AKSAMLAR ELEKTROSTATİK TOZ BOYALI
- POLİETİLEN PLASTİK EKİPMANLAR



110

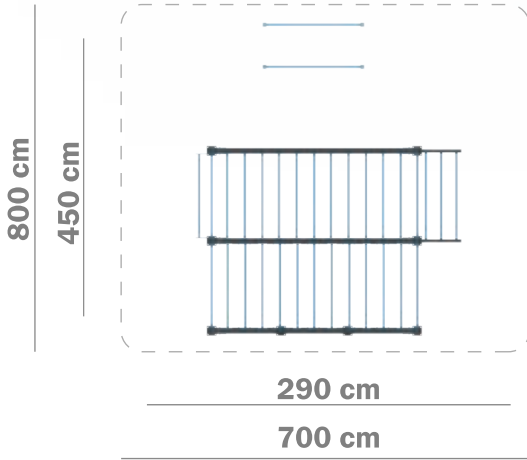

6

Kişi

Kapasite

5

yaş +

Yaş Grubu

Ürün Kodu  
KF - 01







TEKNİK ÖZELLİKLER

- SICAK DALDIRMA GALVANİZ TAŞIYICI
- METAL AKSAMLAR ELEKTROSTATİK TOZ BOYALI
- POLİETİLEN PLASTİK EKİPMANLAR

111

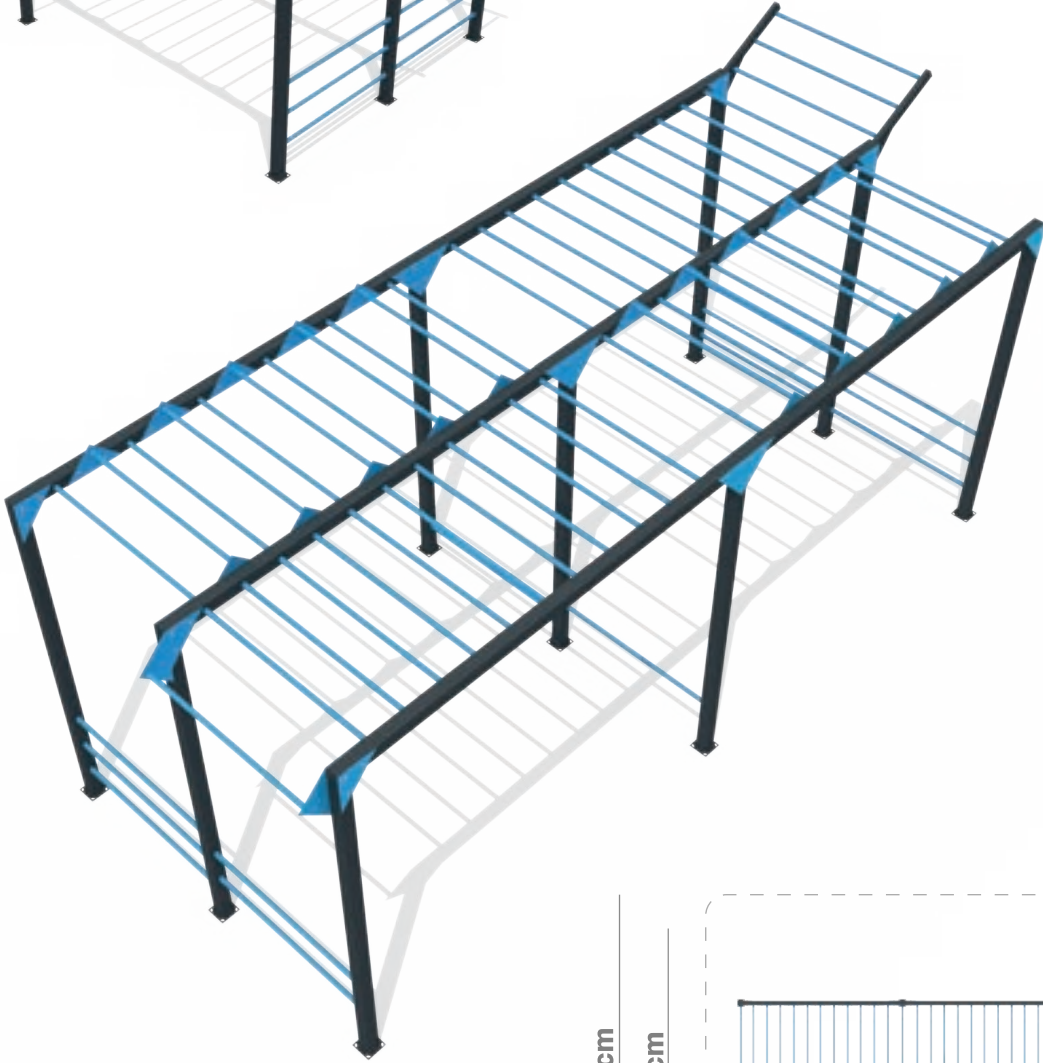

Ürün Kodu  
KF - 02

7  
Kişi  
Kapasite

5  
yaş +  
Yaş Grubu

600 cm

290 cm

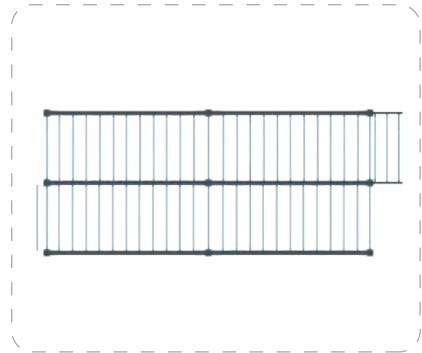

680 cm

1000 cm



**AHŞAP DÜNYASI**  
KENT MOBİLYALARI





TEKNİK ÖZELLİKLER

- SICAK DALDIRMA GALVANİZ TAŞIYICI
- METAL AKSAMLAR ELEKTROSTATİK TOZ BOYALI
- POLİETİLEN PLASTİK EKİPMANLAR



112

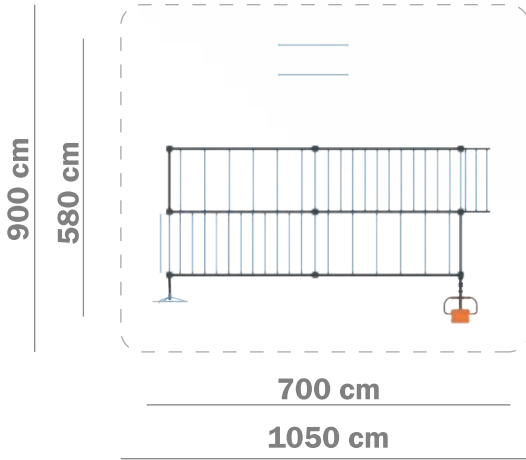

16  
Kişi  
Kapasite

5  
yaş +  
Yaş Grubu

Ürün Kodu  
KF - 03



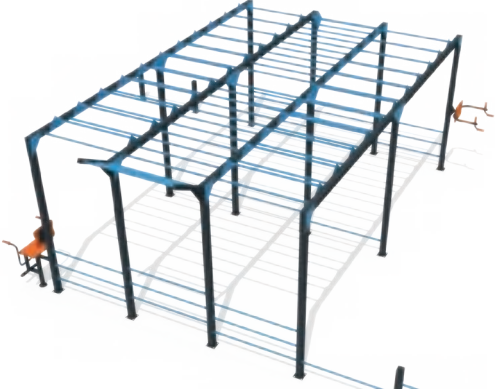

TEKNİK ÖZELLİKLER

- SICAK DALDIRMA GALVANİZ TAŞIYICI
- METAL AKSAMLAR ELEKTROSTATİK TOZ BOYALI
- POLİETİLEN PLASTİK EKİPMANLAR

113



Ürün Kodu  
KF - 04

25  
Kişi

Kapasite

5  
yaş +

Yaş Grubu

1050 cm

690 cm

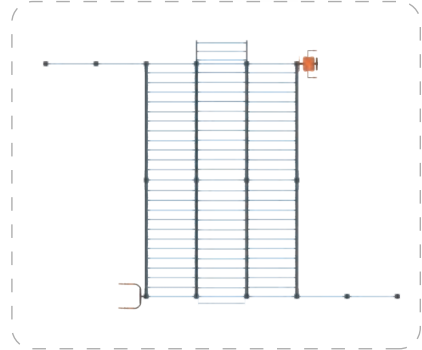

925 cm

1250 cm



**AHŞAP DÜNYASI**  
KENT MOBİLYALARI



## TEKNİK ÖZELLİKLER

- SICAK DALDIRMA GALVANİZ TAŞIYICI
- METAL AKSAMLAR ELEKTROSTATİK TOZ BOYALI
- POLİETİLEN PLASTİK EKİPMANLAR

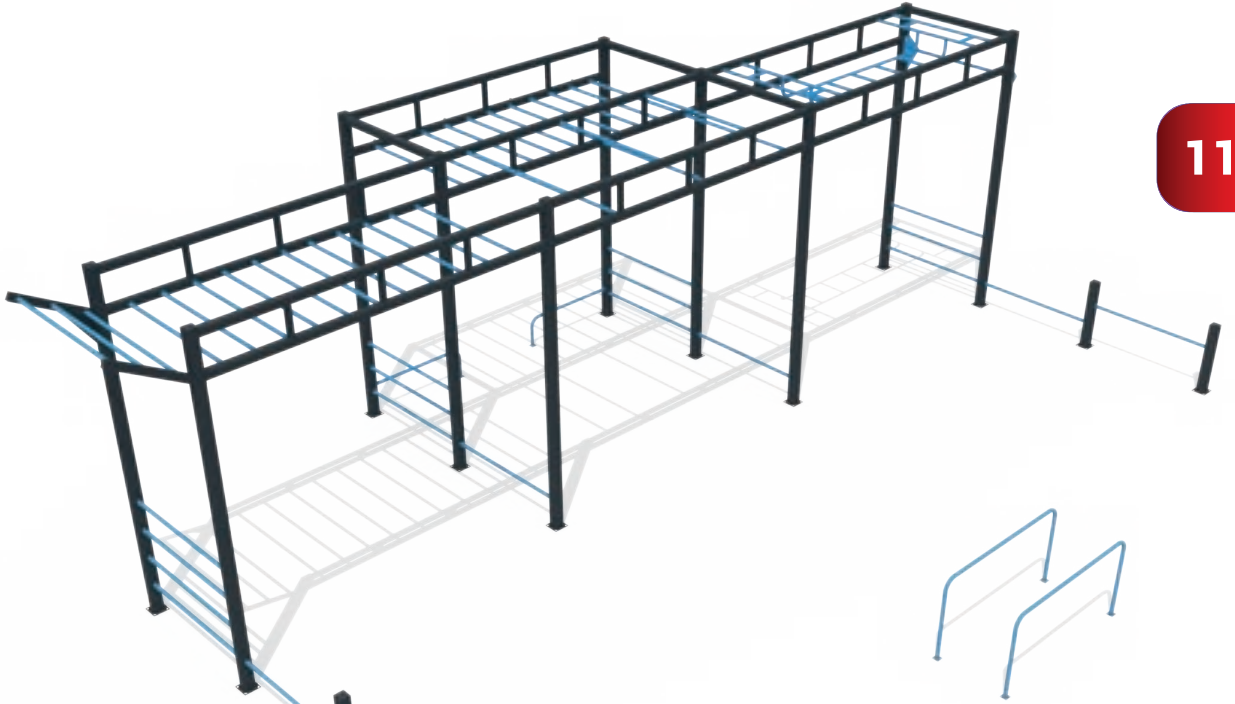

114

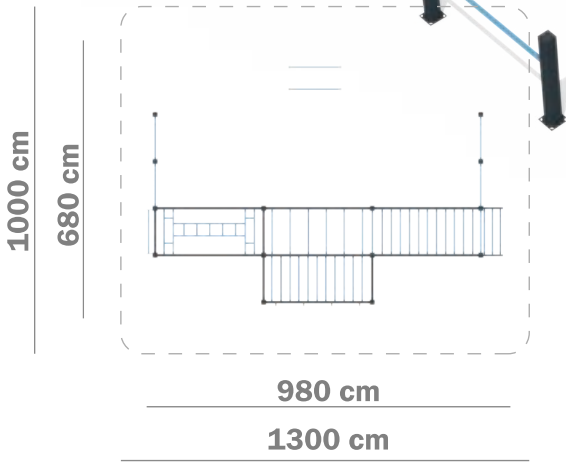

26  
Kişi

Kapasite

5  
yaş +

Yaş Grubu

Ürün Kodu  
KF - 05







# AHŞAP DÜNYASI

KENT MOBİLYALARI



*Dış Mekan  
Spor Aletleri*

# DİŐ MEKAN SPOR ALETLERİ

## KLASİK SERİ - 1



*KOL VE BACAK  
GÜÇLENDİRME ALETİ*

İlün Kodu  
**AFT-01**



İlün Kodu  
**AFT - 02**

*KALÇA VE BEL  
ÇALIŐTIRMA ALETİ*



*ÇİFTLİ BEL  
ÇALIŐTIRMA ALETİ*

İlün Kodu  
**AFT - 03**



İlün Kodu  
**AFT - 04**

*BİSİKLET VE STEP ALETİ*

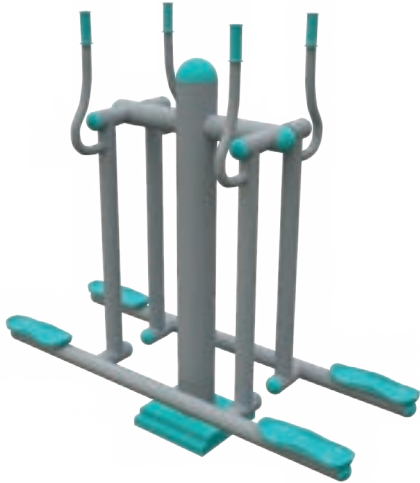

*ÇİFTLİ GEZİNİM ALETİ*

İlün Kodu  
**AFT - 05**

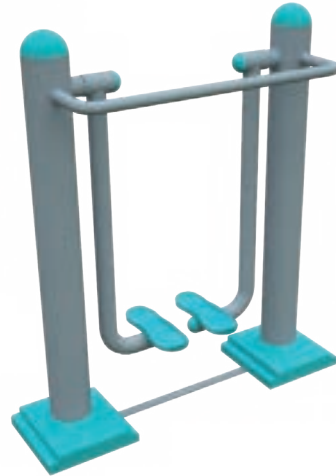

İlün Kodu  
**AFT - 06**

*HAVADA YÜRÜYÜŐ ALETİ*

116



*DİŐ MEKAN SPOR ALETLERİ*  
*KLASİK SERİ - 1*

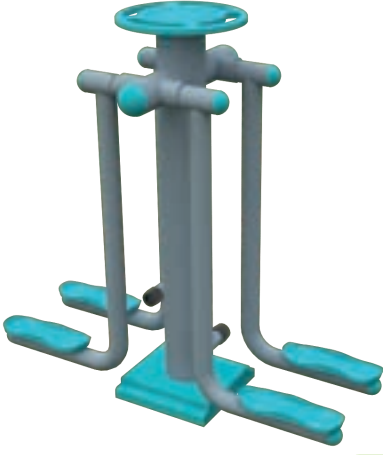

*BACAK GÜÇLENDİRME ALETİ*

*Ürün Kodu*  
**AFT-07**



*Ürün Kodu*  
**AFT - 08**

*KOL ÇALIŐTIRMA ALETİ*

117



*BARFİRS ALETİ*

*Ürün Kodu*  
**AFT - 09**



*Ürün Kodu*  
**AFT - 10**

*MERİK SİNAV*  
*KOL GELİŐTİRME ALETİ*



*KONDİSYON KÜREĐİ*

*Ürün Kodu*  
**AFT - 11**

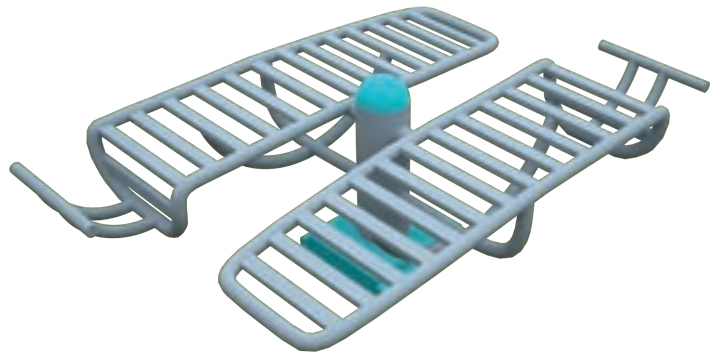

*Ürün Kodu*  
**AFT - 12**

*MERİK ALETİ*



**AHŐAP DÜNYASI**  
KENT MOBİLYALARI

[www.ahsapdunyasi.com.tr](http://www.ahsapdunyasi.com.tr)

[info@ahsapdunyasi.com.tr](mailto:info@ahsapdunyasi.com.tr)







*DÖNER SALINCAK  
ERİPMANİ*

*İlvin Kodu*  
**AFT-13**



*ALT KARIN  
ÇALIŐTIRMA ERİPMANİ*

*İlvin Kodu*  
**AFT - 14**



*DÖNER KOL ERİPMANİ*

*İlvin Kodu*  
**AFT - 15**



*ELİPTİK BİSİKLET ERİPMANİ*

*İlvin Kodu*  
**AFT - 16**

**118**



*DÜŐÜR HIZDA  
YÜRÜYÜŐ ERİPMANİ*

*İlvin Kodu*  
**AFT - 17**



*YATAY BİSİKLER ELEMANİ*

*İlvin Kodu*  
**AFT - 18**



# DİŐ MEKAN SPOR ALETLERİ

PANOLU İRİLİ  
FITNESS EKİPMANLARI



PANOLU BACAK AÇMA  
BACAK AĞIRLIK ALETİ

Ürün Kodu  
AFT-19



PANOLU BACAK AÇMA  
YAN SALINIM ALETİ

Ürün Kodu  
AFT - 20

119



PANOLU  
BEL ÇEVİRME ALETİ

Ürün Kodu  
AFT - 21



PANOLU BEL ÇEVİRME  
STEP ALETİ

Ürün Kodu  
AFT - 22



PANOLU  
BİSİKLET - JOKEY ALETİ

Ürün Kodu  
AFT - 23



PANOLU HAVADA ÇİFTLİ  
GEZİNİM ALETİ

Ürün Kodu  
AFT - 24



**AHSAP DÜNYASI**  
KENT MOBİLYALARI

www.ahsapdunyasi.com.tr

info@ahsapdunyasi.com.tr



# DİŐ MEKAN SPOR ALETLERİ

PANOLU İRİLİ  
FITNESS EKİPMANLARI



PANOLU İKİ BACAK  
ÇALIŐTIRMA ALETİ

İlvin Kodu  
AFT - 25



İlvin Kodu  
AFT - 26

PANOLU İRİLİ  
VÜCUT GELİŐTİRME ALETİ



PANOLU ROL BİLEK  
ÇEVİRME ALETİ

İlvin Kodu  
AFT - 27



İlvin Kodu  
AFT - 28

PANOLU KÜREK ÇERME  
UZAY YÜRÜYÜŐ ALETİ

120



PANOLU SIRT  
MASAJ ALETİ

İlvin Kodu  
AFT - 29



İlvin Kodu  
AFT - 30

PANOLU ŐINAV MERİK  
ELİPTİK ALETİ





# DİŐ MEKAN SPOR ALETLERİ

PANOLU ÜCLÜ  
FITNESS EKİPMANLARI



*BEL ÇEVİRME  
KOL BİLEK ÇALIŐTIRMA*

Ürün Kodu  
AFT - 31



*SIRT MASAJ  
AYARTE BİLEK ÇEVİRME*

Ürün Kodu  
AFT - 32

121



*STEP - BACAK AÇMA  
BACAK AĞIRLIK*

Ürün Kodu  
AFT - 33



*UZAY YÜRÜYÜŐ  
BİSİKLET - KÜREK ÇERME*

Ürün Kodu  
AFT - 34



Ürün Kodu  
AFT - 35

*YANA SALINIM-  
VÜCUT GELİŐTİRME  
BACAK ÇALIŐTIRMA*



**AHŐAP DÜNYASI**  
KENT MOBİLYALARI

www.ahsapdunyasi.com.tr

info@ahsapdunyasi.com.tr





122

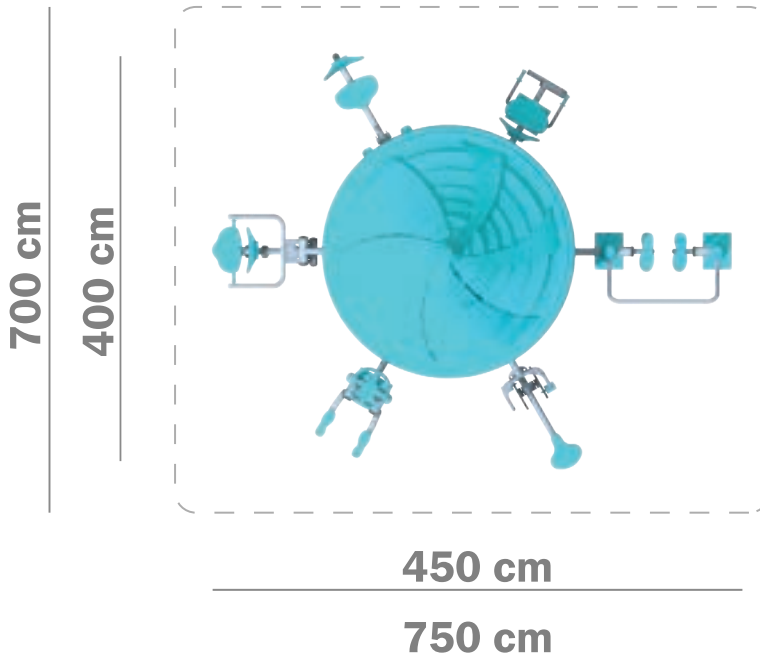

*Ürün Kodu*  
**AFT - 36**

*ALTIGEN FITNESS*



*DİŐ MEKAN SPOR ALETLERİ*  
*FITNESS İSTASYONU*

123



700 cm

400 cm

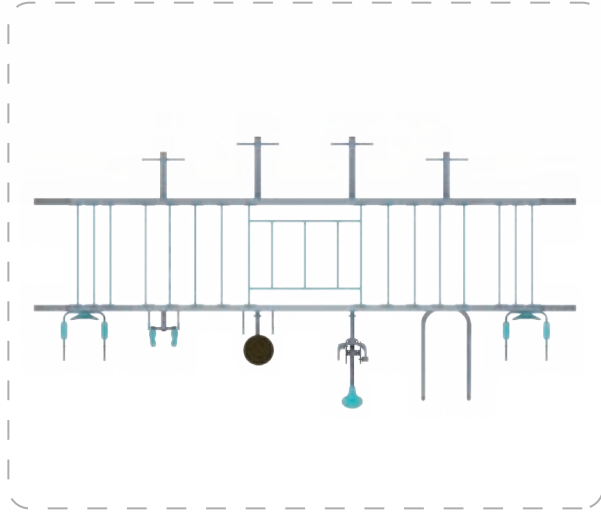

850 cm

1000 cm

*Ürün Kodu*  
**AFT - 37**

*FITNESS İSTASYONU*



**AHSAP DÜNYASI**  
KENT MOBİLYALARI



[www.ahsapdunyasi.com.tr](http://www.ahsapdunyasi.com.tr)

[info@ahsapdunyasi.com.tr](mailto:info@ahsapdunyasi.com.tr)



# DİŐ MEKAN SPOR ALETLERİ

ENGELSİZ  
FITNESS EKİPMANLARI

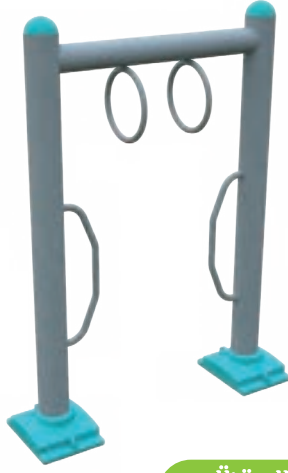

ENGELSİZ ASKI  
BAR ALETİ

Ürün Kodu  
AFT - 38

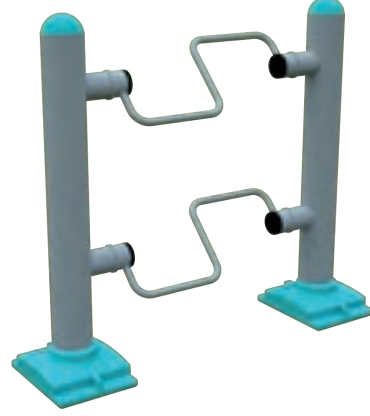

Ürün Kodu  
AFT - 39

ENGELSİZ AYAK KOL  
ÇALIŐTIRMA ALETİ



ENGELSİZ EL  
ÇALIŐTIRMA ALETİ

Ürün Kodu  
AFT - 40



Ürün Kodu  
AFT - 41

ENGELSİZ HALTER ALETİ

124

ENGELSİZ  
KOL - BİLEK  
ÇALIŐTIRMA ALETİ

Ürün Kodu  
AFT - 42

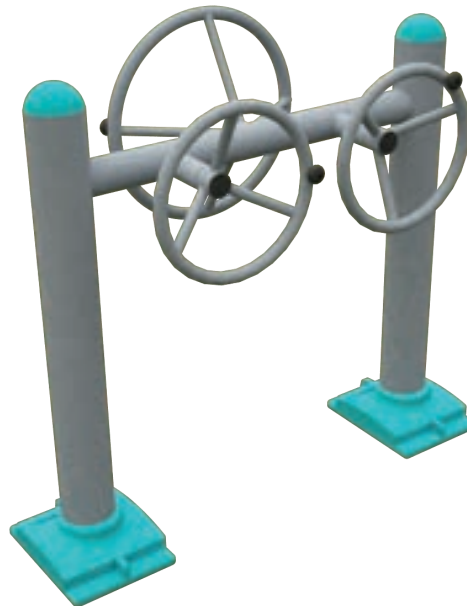



# AHŞAP DÜNYASI

KENT MOBİLYALARI



*Kamelyalar*



Ürün Kodu  
ADK-01

1. SINIF  
EMPRENİYELİ SARIÇAM

126



Ürün Kodu  
ADK-02

1. SINIF  
EMPRENİYELİ SARIÇAM





# KAMELYALAR



Ürün Kodu  
**ADK-03**

**1. SINIF**  
**EMPRENYELİ SARIÇAM**

127



Ürün Kodu  
**ADK-04**

**1. SINIF**  
**EMPRENYELİ SARIÇAM**



**AHŞAP DÜNYASI**  
KENT MOBİLYALARI



[www.ahsapdunyasi.com.tr](http://www.ahsapdunyasi.com.tr)

[info@ahsapdunyasi.com.tr](mailto:info@ahsapdunyasi.com.tr)



Ürün Kodu  
**ADK-05**

**1. SINIF**  
**EMPRENYELİ SARIÇAM**

**128**



Ürün Kodu  
**ADK-06**

**DIŞBUDAK KAMELYA**



# KAMELYALAR



Ürün Kodu  
ADK-07

İREKO KAMELYA

129



Ürün Kodu  
ADK-08

ALTIĞEN  
METAL KAMELYA



**AHŞAP DÜNYASI**  
KENT MOBİLYALARI



[www.ahsapdunyasi.com.tr](http://www.ahsapdunyasi.com.tr)

[info@ahsapdunyasi.com.tr](mailto:info@ahsapdunyasi.com.tr)





Ürün Kodu  
ADK-09

KARE  
METAL KAMELYA

130



Ürün Kodu  
ADK-10

SERİZGEN  
METAL KAMELYA





# AHŞAP DÜNYASI

KENT MOBİLYALARI



*Pergoleler*



Ürün Kodu  
ADP - 01

1. SINIF  
EMPRENİYELİ SARIÇAM



132

Ürün Kodu  
ADP - 02

1. SINIF  
KAHVERENGİ  
EMPRENİYELİ SARIÇAM



Ürün Kodu  
ADP - 03

1. SINIF  
EMPRENİYELİ SARIÇAM





# PERGOLELER

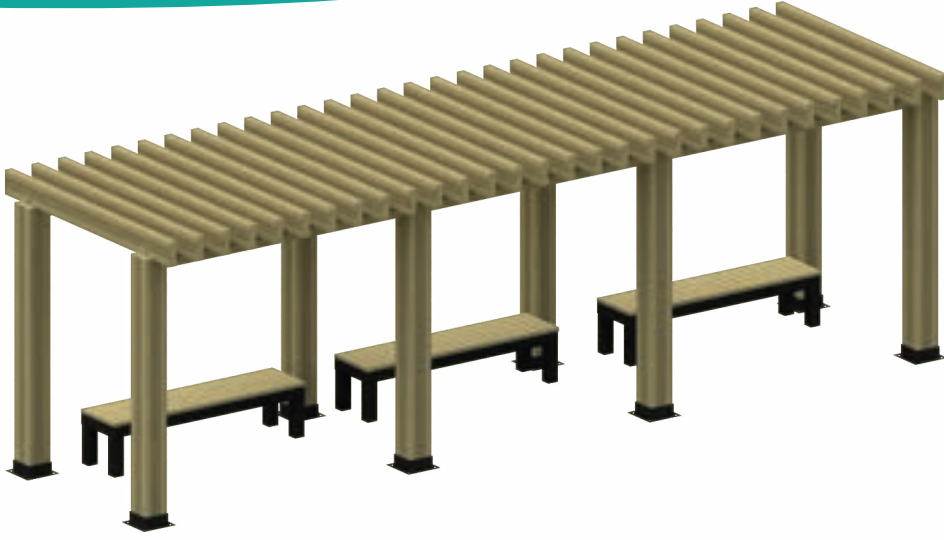

Ürün Kodu  
ADP - 04

1. SINIF  
EMPRENYELİ SARIÇAM

133

Ürün Kodu  
ADP - 05

DISBUDAK  
PERGOLE



Ürün Kodu  
ADP - 06

1. SINIF  
EMPRENYELİ SARIÇAM



**AHŞAP DÜNYASI**  
KENT MOBİLYALARI



[www.ahsapdunyasi.com.tr](http://www.ahsapdunyasi.com.tr)

[info@ahsapdunyasi.com.tr](mailto:info@ahsapdunyasi.com.tr)

Ürün Kodu  
ADP - 07

1. SINIF  
EMPRENİYELİ SARIÇAM

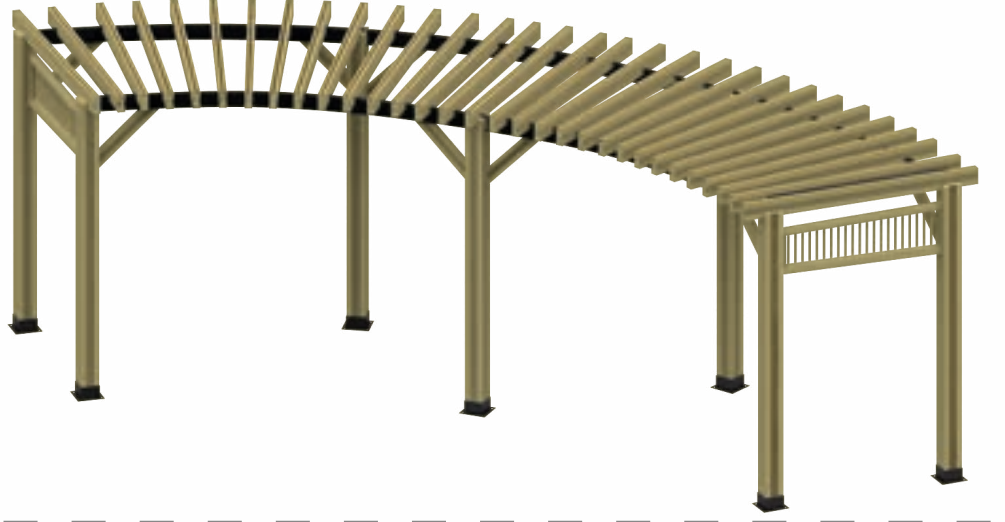

134

Ürün Kodu  
ADP - 08

1. SINIF  
EMPRENİYELİ SARIÇAM

Ürün Kodu  
ADP - 09

1. SINIF  
EMPRENİYELİ SARIÇAM



# PERGOLELER



135

Ürün Kodu  
ADP - 10

1. SINIF  
EMPRENYELİ SARIÇAM



Ürün Kodu  
ADP - 11

1. SINIF  
EMPRENYELİ SARIÇAM



**AHŞAP DÜNYASI**  
KENT MOBİLYALARI



[www.ahsapdunyasi.com.tr](http://www.ahsapdunyasi.com.tr)

[info@ahsapdunyasi.com.tr](mailto:info@ahsapdunyasi.com.tr)





Ürün Kodu  
ADP - 12

IREKO PERGOLE

136



Ürün Kodu  
ADP - 13

IREKO PERGOLE





# AHŞAP DÜNYASI

KENT MOBİLYALARI



*Piknik  
Masaları*





*Ürün Kodu*  
**ADPM - 01**

*TEAK*  
*PIKNİK MASASI*

**138**



*Ürün Kodu*  
**ADPM - 02**

*1. SINIF*  
*EMPRENYELİ SARIÇAM*





# PIKNİK MASALARI



Ürün Kodu  
**ADPM - 03**

1. SINIF  
EMPRENİYELİ SARIÇAM

139



Ürün Kodu  
**ADPM - 04**

1. SINIF  
EMPRENİYELİ SARIÇAM



Ürün Kodu  
**ADPM - 05**

1. SINIF  
EMPRENİYELİ SARIÇAM



**AHSAP DÜNYASI**  
KENT MOBİLYALARI

[www.ahsapdunyasi.com.tr](http://www.ahsapdunyasi.com.tr)

[info@ahsapdunyasi.com.tr](mailto:info@ahsapdunyasi.com.tr)





Ürün Kodu  
**ADPM - 06**

1. SINIF  
EMPRENİYELİ SARIÇAM

140

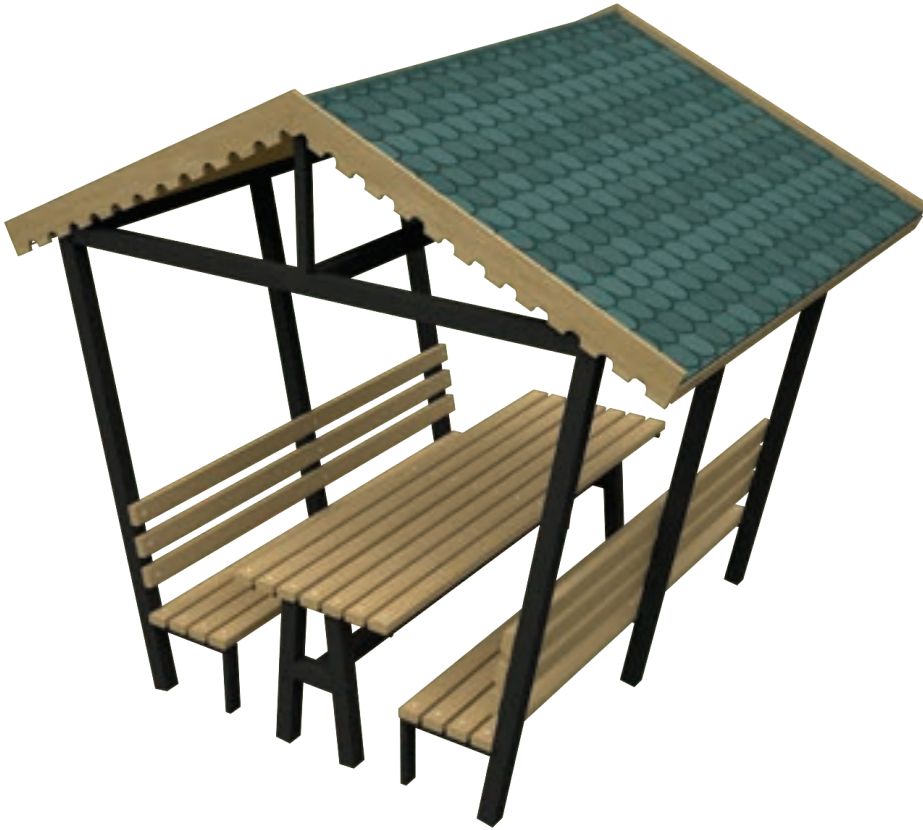

Ürün Kodu  
**ADPM - 07**

1. SINIF  
EMPRENİYELİ SARIÇAM







# AHŞAP DÜNYASI

KENT MOBİLYALARI



*Banklar*





Ürün Kodu  
ADB - 01

Ürün Kodu  
ADB- 02



142



Ürün Kodu  
ADB - 03

Ürün Kodu  
ADB - 04



Ürün Kodu  
ADB - 05



# BANKLAR



Ürün Kodu  
ADB - 06

Ürün Kodu  
ADB- 07



Ürün Kodu  
ADB - 08

143



Ürün Kodu  
ADB - 09



Ürün Kodu  
ADB - 10



**AHSAP DÜNYASI**  
KENT MOBİLYALARI



[www.ahsapdunyasi.com.tr](http://www.ahsapdunyasi.com.tr)

[info@ahsapdunyasi.com.tr](mailto:info@ahsapdunyasi.com.tr)



Ürün Kodu  
ADB - 11

Ürün Kodu  
ADB- 12



144



Ürün Kodu  
ADB - 13

Ürün Kodu  
ADB - 14



Ürün Kodu  
ADB - 15





# BANKLAR



Ürün Kodu  
ADB - 16



Ürün Kodu  
ADB- 17

145



Ürün Kodu  
ADB - 18

Ürün Kodu  
ADB - 19



**AHSAP DÜNYASI**  
KENT MOBİLYALARI



[www.ahsapdunyasi.com.tr](http://www.ahsapdunyasi.com.tr)

[info@ahsapdunyasi.com.tr](mailto:info@ahsapdunyasi.com.tr)

Ürün Kodu  
ADB- 20



Ürün Kodu  
ADB- 21



146

Ürün Kodu  
ADB- 22



Ürün Kodu  
ADB- 23



# BANKLAR

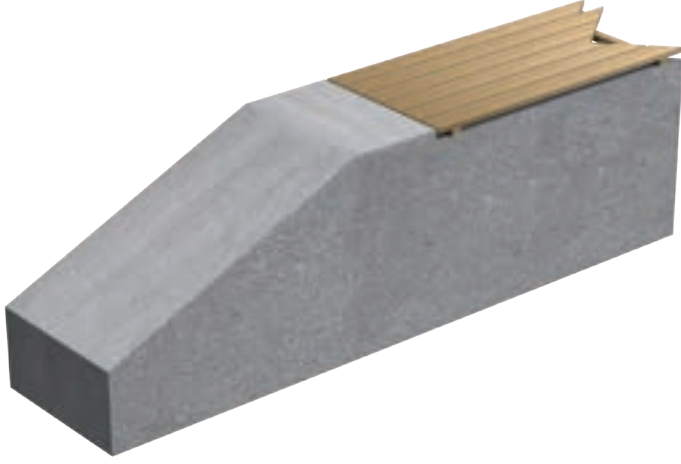

Ürün Kodu  
ADB - 24

147



Ürün Kodu  
ADB- 25



Ürün Kodu  
ADB - 26



**AHSAP DÜNYASI**  
KENT MOBİLYALARI



[www.ahsapdunyasi.com.tr](http://www.ahsapdunyasi.com.tr)

[info@ahsapdunyasi.com.tr](mailto:info@ahsapdunyasi.com.tr)



Ürün Kodu  
ADB- 27



148

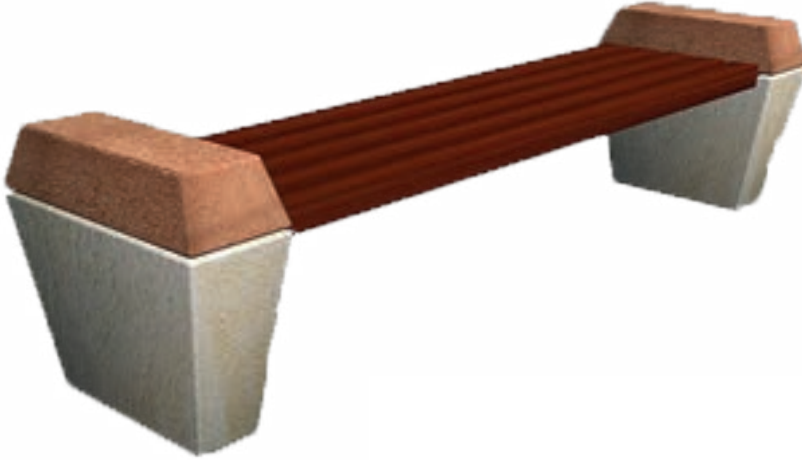

Ürün Kodu  
ADB - 28

Ürün Kodu  
ADB- 29





# AHŞAP DÜNYASI

KENT MOBİLYALARI



*Çöp Kovaları*

# ÇÖP KOVALARI



Ürün Kodu  
ADÇ - 01

Ürün Kodu  
ADÇ - 02



150



Ürün Kodu  
ADÇ - 03

Ürün Kodu  
ADÇ - 04



Ürün Kodu  
ADÇ - 05





# ÇÖP KOVALARI



Ürün Kodu  
ADÇ - 06

Ürün Kodu  
ADÇ - 07



Ürün Kodu  
ADÇ - 08



Ürün Kodu  
ADÇ - 09



Ürün Kodu  
ADÇ - 10



151



**AHSAP DÜNYASI**  
KENT MOBİLYALARI



[www.ahsapdunyasi.com.tr](http://www.ahsapdunyasi.com.tr)

[info@ahsapdunyasi.com.tr](mailto:info@ahsapdunyasi.com.tr)

# ÇÖP KOVALARI



Ürün Kodu  
ADÇ - 12

Ürün Kodu  
ADÇ - 11



152



Ürün Kodu  
ADÇ - 14

Ürün Kodu  
ADÇ - 13



Ürün Kodu  
ADÇ - 15



# ÇÖP KOVALARI



Ürün Kodu  
ADÇ - 16

Ürün Kodu  
ADÇ - 17

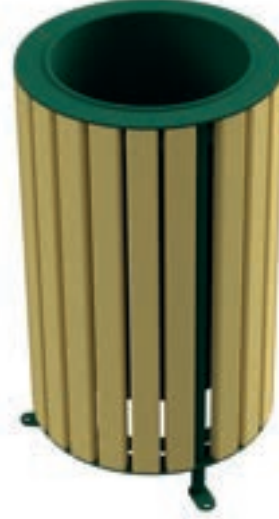

Ürün Kodu  
ADÇ - 18



Ürün Kodu  
ADÇ - 19



Ürün Kodu  
ADÇ - 20



**AHSAP DÜNYASI**  
KENT MOBİLYALARI



[www.ahsapdunyasi.com.tr](http://www.ahsapdunyasi.com.tr)

[info@ahsapdunyasi.com.tr](mailto:info@ahsapdunyasi.com.tr)

153



# ÇÖP KOVALARI



Ürün Kodu  
ADÇ - 21

Ürün Kodu  
ADÇ - 22



154

Ürün Kodu  
ADÇ - 23

Ürün Kodu  
ADÇ - 24



Ürün Kodu  
ADÇ - 25

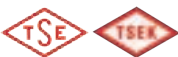



# AHŞAP DÜNYASI

KENT MOBİLYALARI



*Gerİ Dönüşüm  
Üniteleri*



# GERİ DÖNÜŞİM ÜNİTELERİ



Ürün Kodu  
ADGD - 01



156

Ürün Kodu  
ADGD - 02



Ürün Kodu  
ADGD - 03





# GERİ DÖNÜŞÜM ÜNİTELERİ



İlgin Kodu  
ADGD - 04

157

İlgin Kodu  
ADGD - 05



İlgin Kodu  
ADGD - 06



İlgin Kodu  
ADGD - 07



**AHSAP DÜNYASI**  
KENT MOBİLYALARI



# GERİ DÖNÜŞÜM ÜNİTELERİ

Ürün Kodu  
ADGD - 08



Ürün Kodu  
ADGD - 09

158

Ürün Kodu  
ADGD - 10



Ürün Kodu  
ADGD - 11







# AHŞAP DÜNYASI

KENT MOBİLYALARI



*Çiçeklik*



Ürün Kodu  
ADÇI - 01



Ürün Kodu  
ADÇI - 02

160

Ürün Kodu  
ADÇI - 03



Ürün Kodu  
ADÇI - 04

Ürün Kodu  
ADÇI - 05





# AHŞAP DÜNYASI

KENT MOBİLYALARI



*Bisiklet Parkı*

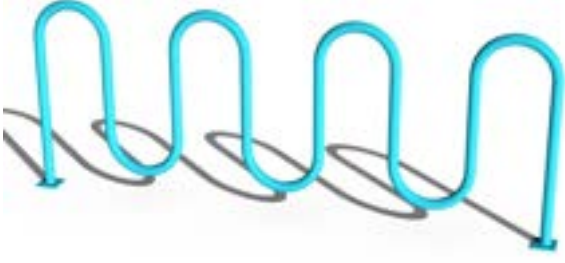

Ürün Kodu  
ADBS - 01



Ürün Kodu  
ADBS - 02

162



Ürün Kodu  
ADBS - 03

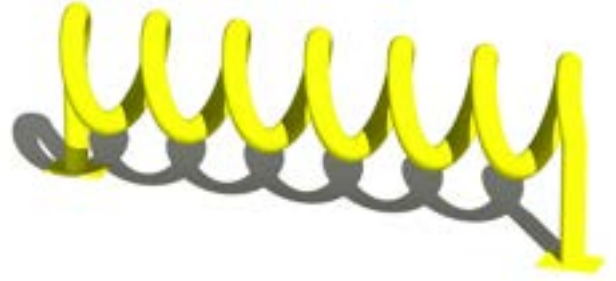

Ürün Kodu  
ADBS - 04







# AHŞAP DÜNYASI

KENT MOBİLYALARI



*Ahsap Çitler*

İlvin Kodu  
ADÇT - 01

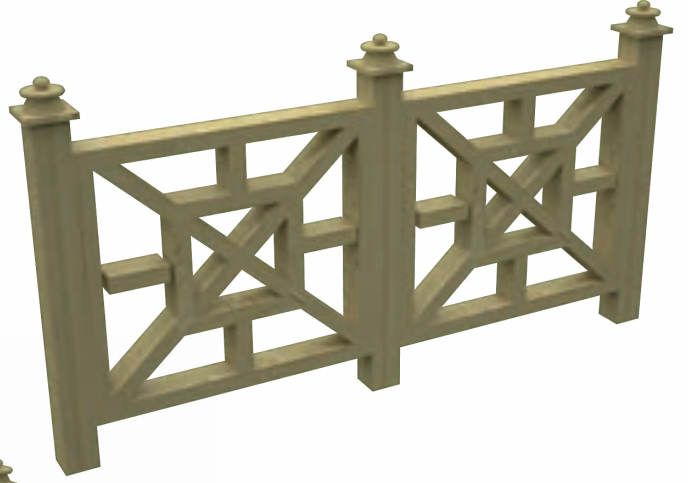

İlvin Kodu  
ADÇT - 02

164



İlvin Kodu  
ADÇT - 03



İlvin Kodu  
ADÇT - 04







# AHŞAP DÜNYASI

KENT MOBİLYALARI



*Hayvan Barınakları*





Ürün Kodu  
ADH - 01

KÜMES

166

Ürün Kodu  
ADH - 02  
KÖPEK KULÜBESİ



Ürün Kodu  
ADH - 03

KUŞ EVİ





# AHŞAP DÜNYASI

KENT MOBİLYALARI



*Diğer  
Ekipmanlar*

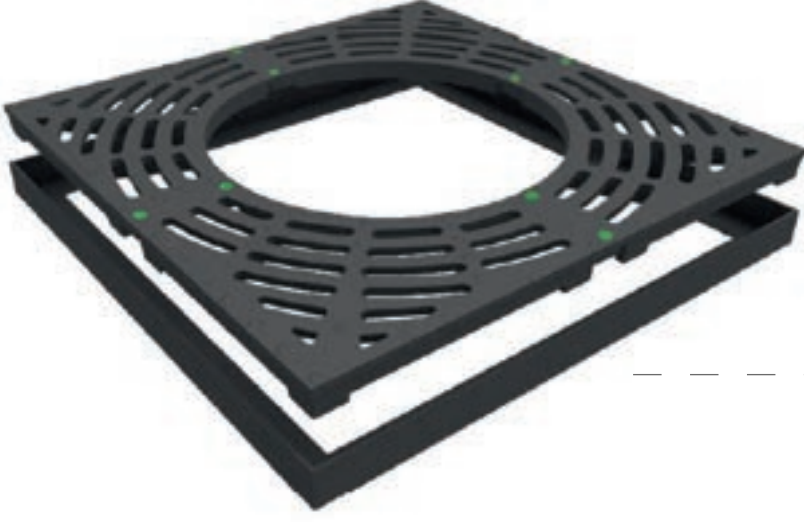

*Ürün Kodu*  
**ADDE - 01**

*AĞAÇ ALTI IZGARA*

**168**



*Ürün Kodu*  
**ADDE - 02**

*ARAÇ SONLANDIRMA  
BARIYERİ*



*Ürün Kodu*  
**ADDE - 03**

*BETON BARIYER*





# SPOR SAHASI EKİPMANLARI



Ürün Kodu  
**ADSE - 01**

*VOLEYBOL SAHASI*

Ürün Kodu  
**ADSE - 02**

*TENİS SAHASI*



169



Ürün Kodu  
**ADSE - 03**

*BASKETBOL SAHASI*

Ürün Kodu  
**ADSE - 04**

*BASKETBOL SAHASI*



Ürün Kodu  
**ADSE - 05**

*FUTBOL KALESİ*



**AHSAP DÜNYASI**  
KENT MOBİLYALARI



[www.ahsapdunyasi.com.tr](http://www.ahsapdunyasi.com.tr)

[info@ahsapdunyasi.com.tr](mailto:info@ahsapdunyasi.com.tr)



Ürün Kodu  
ADZ- 01

KAUÇUK ZEMİN  
DÖŞEMESİ



Ürün Kodu  
ADZ- 02

EPDM ZEMİN KAPLAMA

170



Ürün Kodu  
ADZ- 03

AKRİLİK  
ZEMİN

Ürün Kodu  
ADZ- 04

SENTETİK ÇİM

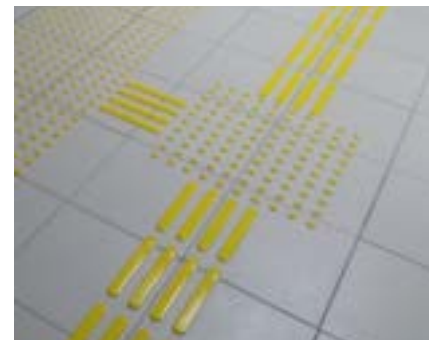
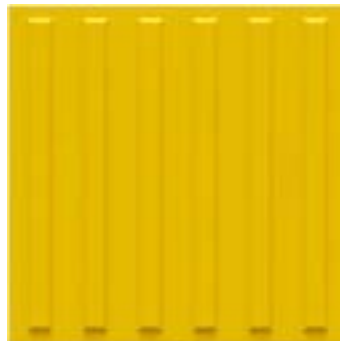

Ürün Kodu  
ADZ- 05

HİSSEDİLEBİLİR YÜZEY























# REFERANSLAR

- T.C. BAŞBAKANLIK TOPLU KONUT İDARESİ BAŞKANLIĞI
- ADALET BAKANLIĞI
- GENÇLİK VE SPOR BAKANLIĞI
- TÜRKİYE İŞ BANKASI
- TAPU KADASTRO GENEL MÜDÜRLÜĞÜ
- ANKARA İVEDİK ORGANİZE SANAYİ BÖLGESİ
- ŞANLIURFA BELEDİYESİ
- KARA KUVVETLERİ KOMUTANLIĞI
- NIĞDE İL ORMAN MÜDÜRLÜĞÜ
- JANDARMA GENEL KOMUTANLIĞI
- BİTLİS BELEDİYESİ
- AĞRI BELEDİYESİ
- BORNOVA BELEDİYESİ
- PURSAKLAR BELEDİYESİ
- SİNCAN BELEDİYESİ
- SEYHAN BELEDİYESİ
- GÖLBAŞI BELEDİYESİ
- ERCİŞ BELEDİYESİ
- MAKSEM YAPI TİC. A.Ş.
- DBN PROJE MÜHENDİSLİK İNŞAAT A.Ş.
- ORAKA İNŞAAT TAAHHÜT SAN. TİC. LTD. ŞTİ.
- DEMARS İNŞAAT TURİZM TİC. LTD. ŞTİ.
- ERGEZEN YAPI TİC. LTD. ŞTİ.
- EN-SA YAPI VE İNŞAAT SAN. A.Ş.
- YENİ FİDAN İNŞAAT TİC. LTD. ŞTİ.
- AKZEMİN MÜHENDİSLİK A.Ş.
- DİBAY İNŞAAT TURİZM SAN. TİC. LTD. ŞTİ.
- DEMRAZ GRUP İNŞAAT SAN. TİC. A.Ş.
- DEMİREL YAPI MALZ. İNŞAAT TİC. LTD. ŞTİ.
- GÜRAS MÜHENDİSLİK MİMARLIK İNŞAAT TİC. LTD. ŞTİ.
- KOCAMAN İNŞAAT TİC. LTD. ŞTİ.
- ILGIN İNŞAAT İÇ VE DIŞ TİC. A.Ş.
- ÖZYAPI ELEKTRİK MAKİNA SAN. TİC. LTD. ŞTİ.
- STAR LIFE İNŞAAT TİC. LTD. ŞTİ.
- CENTİLMEN İNŞAAT LTD. ŞTİ.
- KARMEL GAYRİMENKUL İNŞAAT LTD. ŞTİ.
- MAY İNŞAAT TİC. LTD. ŞTİ.
- MAKROBİN İNŞAAT TİCARET SANAYİ A.Ş.
- GÜNGÖR İNŞAAT TAAHHÜT TİC. LTD. ŞTİ.
- MİRZAN İNŞAAT TİC. LTD. ŞTİ.
- KOM YAPI İNŞAAT TİC. A.Ş.
- ÖZ-ER-KA İNŞAAT TAAHHÜT LTD. ŞTİ.





# AHŞAP DÜNYASI

KENT MOBİLYALARI